

Mobile Crane Grue mobile

LTM 1095-5.1

Technical Data Caractéristiques techniques

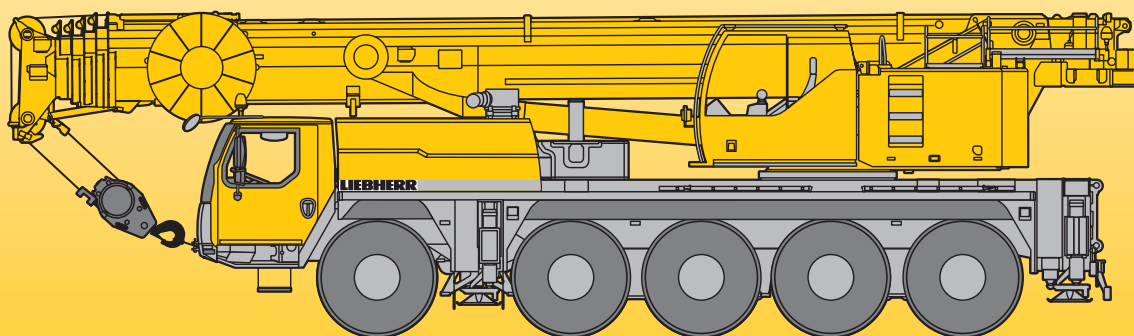

LIEBHERR

Dimensions Encombrement

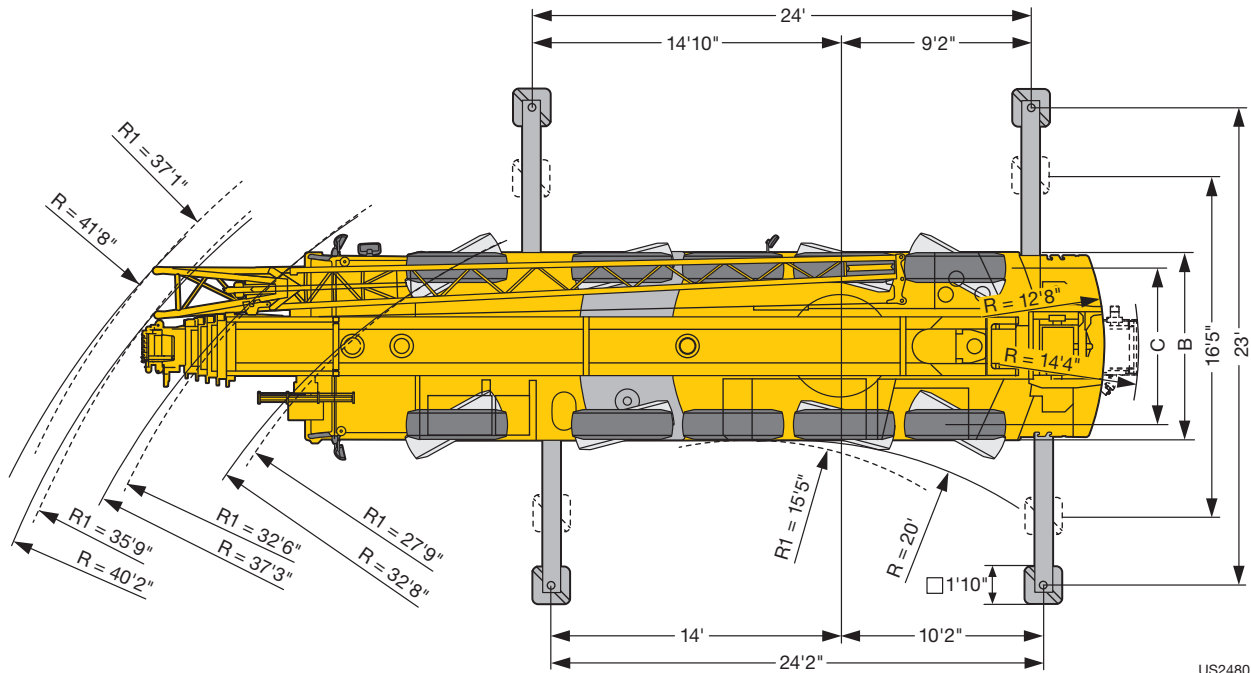
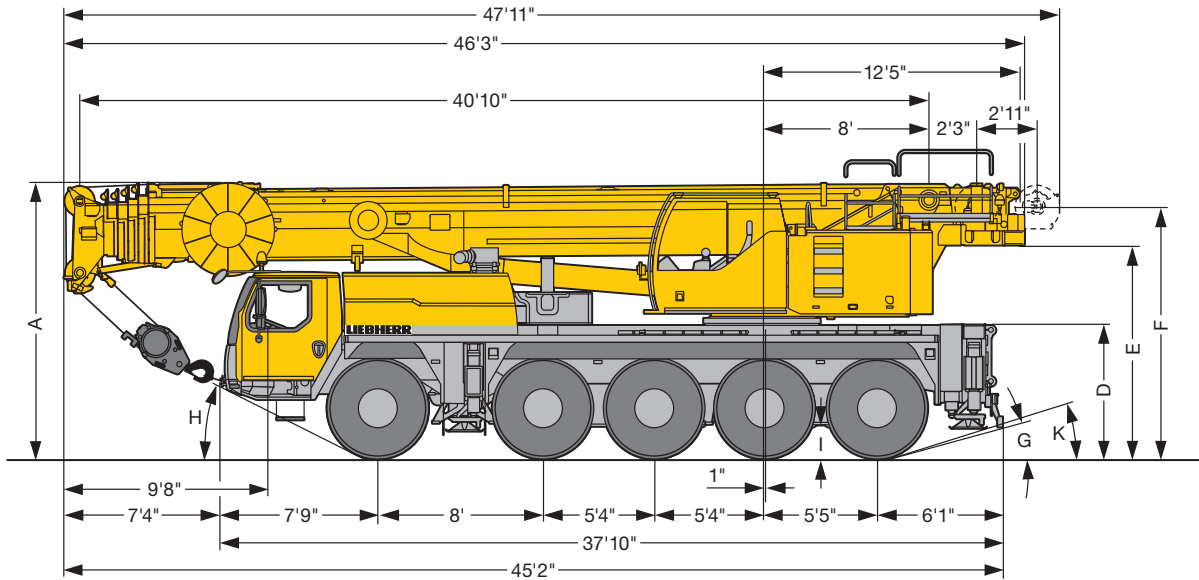

US2480.01

R₁ = All-wheel steering · Direction toutes roues

	Dimensions · Encombrement										
	A	A	B	C	D	E	F	G	H	I	K
445/95 R 25 (16.00 R 25)	13'1"	0'4" *	9'	7'7"	6'4"	10'1"	12'3"	13°	25°	1'5"	16°
525/80 R 25 (20.5 R 25)	13'1"	12'10"	9'9"	8'	6'4"	10'1"	12'3"	13°	25°	1'5"	16°

* lowered · abaissé

Weights Poids



Axle Essieu lbs	1	2	3	4	5	Total weight lbs Poids total lbs
	26400	26400	26400	26400	26400	132000 ¹⁾

¹⁾ with 33100 lbs counterweight and folding jib · avec contrepoids 33100 lbs et fléchette pliante



Load kips Forces de levage kips	No. of sheaves Poulies	No. of lines Brins	Weight lbs Poids lbs
176.4	7	14	1102
128.7	5	11	1102
84.4	3	7	992
35.3	1	3	661
12.6	–	1	308

Working speeds Vitesses







		1	2	3	4	5	6	7	8	9	10	11	12	R 1	R 2	
445/95 R 25 (16.00 R 25)	mph	1.2 – 3.5	4.5	5.8	7.5	9.5	12.2	16.1	20.6	26.6	34.2	43.4	50	1.3 – 3.8	4.9	43 %
525/80 R 25 (20.5 R 25)		0.53 – 1.6	2	2.6	3.3	4.2	5.3	7	9	11.6	14.9	18.9	24.2	0.57 – 1.7	2.1	55 %



Drive Mécanismes	ininitely variable en continu	Rope diameter / Rope length Diamètre du câble / Longueur du câble	Max. single line pull Effort au brin maxi.
	0 – 393 ft/min single line ft/min au brin simple	0.7" / 853'	12820 lbs
	0 – 393 ft/min single line ft/min au brin simple	0.7" / 853'	12820 lbs
	0 – 1.7 rpm		
	approx. 60 seconds to reach 82° boom angle env. 60 s jusqu'à 82°		
	approx. 390 seconds for boom extension from 41 ft – 190 ft env. 390 s pour passer de 41 ft – 190 ft		

Lifting capacities Forces de levage

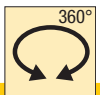
T

41 – 190 ft    360°  50700 lbs **85%**







ft	ft												ft	
	41 ft	54 ft	68 ft	82 ft	96 ft	110 ft	123 ft	137 ft	151 ft	165 ft	178 ft	190 ft		
10	188.2	139.5	139.5										10	
11	179.9	139.5	139.5										11	
12	167.1	139.5	139.5	128.8									12	
13	153.8	139.5	138.9	128.4	107								13	
14	149.3	139.5	135.1	126.7	106.9								14	
15	145.2	139.5	130.6	122.1	106.9	84.4							15	
16	141.4	134.1	127	118	106.9	84.4							16	
17	138	127.7	123.8	115.2	106.9	84.4	72.4						17	
18	133	121.7	120.6	111.7	105.9	84.4	72.1						18	
19	125.9	116.1	116.9	108.5	102.6	84.4	71.6						19	
20	118.3	110.7	111.6	105.5	99.5	84.4	71	49.4					20	
22	105.6	101	101.8	100.1	93.8	84.4	69.7	49.4					22	
24	95	92.1	93.1	93	89	83.9	68.4	49.4	43.5				24	
26	86.1	83.7	84.7	84.9	84.2	81.4	66.8	49.4	42.8	33.8			26	
28	78.5	76.5	78.2	77.7	78.3	74.8	64.6	49.2	41.7	33.3			28	
30	72	70.3	72	71.5	72.7	68.8	62.3	48.1	40.5	32.8	25		30	
32	66.3	64.9	66.8	66	67.1	63.4	60.1	46.3	39.2	32.1	25		32	
34			61.9	62	62.1	58.5	57.2	44.6	37.8	31.4	24.7	20	34	
36			57.4	58.2	57.6	54.5	54	42.8	36.4	30.7	24.3	19.8	15.5	36
38			53.5	54.3	53.7	52.2	50.6	41.1	35.2	29.9	23.9	19.6	15.5	38
40			50.1	50.8	50.2	50	47.4	39.6	33.9	29.1	23.4	19.3	15.3	40
45			42.9	43.6	43	43.1	40.9	35.9	31.1	26.9	22.2	18.6	14.6	45
50				37.7	37.9	37.6	35.4	32.6	28.6	24.9	20.9	17.9	14	50
55				34	34.2	33	31.1	29.2	26.2	23.1	19.7	17	13.5	55
60					30.1	29.3	27.4	26.5	24.3	21.4	18.6	16	13	60
65					26.8	26.2	24.4	24.6	22.2	19.9	17.5	15.2	12.5	65
70					23.8	23.4	21.9	22.4	19.7	18.5	16.5	14.4	11.9	70
75						20.9	20.7	20.3	18	17.2	15.5	13.6	11.4	75
80						18.8	19.5	18.4	16.8	15.8	14.6	12.9	10.9	80
85						16.9	17.9	16.8	15.5	14.3	13.7	12.3	10.4	85
90							16.2	15.3	14.6	12.9	12.9	11.6	9.9	90
95							14.8	13.8	13.8	12.2	12	11	9.4	95
100								12.5	12.9	11.5	10.9	10.5	9	100
105								11.5	11.7	10.7	9.9	10	8.5	105
110								10.9	10.7	10	9.3	9.3	8.2	110
115									9.8	9.6	8.8	8.6	7.8	115
120									8.9	8.9	8.4	7.9	7.4	120
125										8.2	7.9	7.2	7	125
130										7.6	7.3	6.6	6.4	130
135										6.9	6.7	6	5.9	135
140											6.1	5.4	5.3	140
145											5.5	4.8	4.8	145
150											5	4.2	4.3	150
155												3.8	3.8	155
160												3.3	3.3	160
165													2.9	165
170													2.5	170
175													2.2	175

* over rear · en arrière

t_208_50101_01_000 / 50301_01_000

Lifting capacities Forces de levage





T

	 41 – 190 ft	 T	 360°	 33100 lbs	85%									
	 41 ft	54 ft	68 ft	82 ft	96 ft	110 ft	123 ft	137 ft	151 ft	165 ft	178 ft	190 ft	 190 ft	
10	139.5	139.5											10	
11	139.5	139.5											11	
12	139.5	139.5	128.8										12	
13	139.5	138.9	128.4	107									13	
14	139.5	135.1	126.7	106.9									14	
15	136.9	130.6	122.1	106.9	84.4								15	
16	130.8	127	118	106.9	84.4								16	
17	123.9	123.8	115.2	106.9	84.4	72.4							17	
18	117.5	118.3	111.7	105.9	84.4	72.1							18	
19	111.4	112.4	108.3	102.6	84.4	71.6							19	
20	105.2	106.3	104.9	97.9	84.4	71	49.4						20	
22	94	95	94.2	90	82.6	69.7	49.4						22	
24	84.8	86.6	83.5	80.6	75	68.4	49.4	43.5					24	
26	76.9	78.7	75.5	72.4	67.7	65.7	49.4	42.8	33.8				26	
28	69.8	71.7	69.6	65.7	63.7	60.5	49.2	41.7	33.3				28	
30	63.9	65.7	63.4	60.1	59	55.5	48.1	40.5	32.8	25			30	
32	58.7	60.4	58.1	55	54.5	50.9	46.3	39.2	32.1	25			32	
34		55.4	53.3	51.8	50	47.1	43.9	37.8	31.4	24.7	20		34	
36		50.9	49.1	48.8	46.4	43.4	40.7	36.4	30.7	24.3	19.8	15.5	36	
38		47	46.7	45.2	43.1	40.5	37.9	35.2	29.9	23.9	19.6	15.5	38	
40		44.3	43.7	42.2	40.1	37.6	35.9	33.8	29.1	23.4	19.3	15.3	40	
45		36.3	37.2	35.8	34.1	32	31.7	28.9	26.9	22.2	18.6	14.6	45	
50			31.8	30.9	29.3	28.1	27.8	25.6	24.3	20.9	17.9	14	50	
55			27.1	27	25.5	25.9	24.3	22.7	21.2	19.7	17	13.5	55	
60				23.7	22.5	23	21.3	20.3	18.9	18.3	16	13	60	
65				20.7	20	20.5	18.9	18.9	17.5	16.5	15.2	12.5	65	
70				18.3	18	18.4	17	17	15.6	14.6	14.4	11.9	70	
75					15.9	16.5	15.8	15.2	14.2	13.7	13.3	11.4	75	
80					14.1	14.8	14.8	13.7	13.4	12.8	11.9	10.9	80	
85					12.6	13.2	13.6	12.4	12.1	11.7	10.6	10.3	85	
90						11.8	12.3	11.3	10.9	10.5	9.5	9.3	90	
95						11.1	11	10.6	10.2	9.5	8.5	8.3	95	
100							9.9	9.8	9.3	8.6	7.6	7.4	100	
105							9	8.8	8.4	7.7	6.8	6.6	105	
110							8.3	8.1	7.6	7	6	5.9	110	
115								7.4	6.9	6.3	5.4	5.2	115	
120								6.7	6.2	5.7	4.8	4.6	120	
125									5.6	5.1	4.2	4.1	125	
130									4.9	4.5	3.7	3.6	130	
135									4.4	3.9	3.2	3.1	135	
140										3.4	2.7	2.6	140	
145										3	2.2	2.2	145	
150										2.6			150	

t_208_50309_01_000

Lifting capacities Forces de levage

T





41 - 190 ft     **85%**

ft	41 ft	54 ft	68 ft	82 ft	96 ft	110 ft	123 ft	137 ft	151 ft	165 ft	178 ft	190 ft	ft
10	139.5	139.5											10
11	139.5	139.5											11
12	139.5	139.5	128.8										12
13	139.5	138.9	128.4	107									13
14	139.5	135.1	126.7	106.9									14
15	136.4	130.6	122.1	106.9	84.4								15
16	129.9	126.9	118	106.9	84.4								16
17	123	123.4	115.2	106.9	84.4	72.4							17
18	116.5	117.5	111.7	105.7	84.4	72.1							18
19	110	111.1	107.2	101.5	84.4	71.6							19
20	103.6	104.8	102.1	95.6	84.3	71	49.4						20
22	92.6	93.6	90.6	86.6	80.6	69.7	49.4						22
24	83.4	85.2	80.3	77.6	72.1	67.9	49.4	43.5					24
26	75.4	77.3	74	69.7	66.7	63.8	49.4	42.8	33.8				26
28	68.5	69.8	67	63.2	62	58.1	49.2	41.7	33.3				28
30	62.6	63.4	60.9	57.5	56.7	53	48.1	40.5	32.8	25			30
32	57.4	57.9	55.5	54	52	48.6	45.4	39.2	32.1	25			32
34		52.8	50.9	50.4	47.8	44.9	41.9	37.8	31.4	24.7	20		34
36		48.5	48.2	46.5	44.3	41.4	39.3	36.3	30.7	24.3	19.8	15.5	36
38		45.7	44.8	43.2	41.1	38.5	36.9	34.6	29.9	23.9	19.6	15.5	38
40		42.2	41.7	40.2	38.2	35.8	34.4	32.2	29.1	23.4	19.3	15.3	40
45		34.5	35.4	34	32.4	30.7	30.5	27.7	26.7	22.2	18.6	14.6	45
50			30.2	29.3	27.8	28	26.4	24.6	23.1	20.9	17.9	14	50
55			25.8	25.6	24.2	24.7	23	21.5	20.3	19.6	17	13.5	55
60				22.5	21.4	21.8	20.2	20.1	18.6	17.6	16	13	60
65				19.6	19.1	19.3	18.2	17.9	16.6	15.5	15.2	12.5	65
70				17.4	17	17.3	16.8	16	15.1	14.5	14	11.9	70
75					14.9	15.5	15.6	14.3	14	13.4	12.4	11.4	75
80					13.2	13.9	14.1	12.8	12.5	12.1	11	10.7	80
85					11.7	12.5	12.7	12	11.5	10.9	9.8	9.6	85
90						11.8	11.4	11.1	10.5	9.8	8.7	8.6	90
95						10.8	10.2	10.1	9.5	8.8	7.8	7.6	95
100							9.2	9.1	8.6	7.9	6.9	6.8	100
105							8.5	8.2	7.8	7.1	6.1	6	105
110							7.7	7.5	7	6.4	5.4	5.3	110
115								6.8	6.3	5.7	4.8	4.6	115
120								6.2	5.6	5.1	4.2	4.1	120
125									5	4.6	3.6	3.5	125
130									4.4	4	3.1	3	130
135									3.9	3.5	2.7	2.6	135
140										3	2.2	2.1	140
145										2.5			145
150										2.1			150

t_208_50312_01_000

Lifting capacities Forces de levage

T

41 – 190 ft  T   360°  8400 lbs  85%

ft	41 ft	54 ft	68 ft	82 ft	96 ft	110 ft	123 ft	137 ft	151 ft	165 ft	178 ft	190 ft	ft
10	139.5	139.5											10
11	139.5	139.5											11
12	138.5	139.3	132.5										12
13	134.9	134.8	131.1	107									13
14	126.3	126.3	125.6	106.1									14
15	118.1	118	116.9	105.1	83.7								15
16	109.6	111	106.6	97.1	83.2								16
17	101.8	103	97.5	91.8	81.3	65.8							17
18	94.8	96.3	89.6	84.7	76.5	65.5							18
19	88.7	90.7	83.8	78.3	71.6	64.9							19
20	83.2	84.5	78.4	72.5	69.5	63.6	50.6						20
22	73.7	72.1	68.1	63.6	60.8	55.8	49.3						22
24	64.3	62.4	59.5	57.9	53.7	49.4	45.5	39.5					24
26	54.5	54.7	54.2	51.3	47.9	44.2	41.8	38.5	30.7				26
28	46.5	49.6	48.4	46	43.1	40.3	37.7	34.8	30.3				28
30	40.3	43.6	43.6	41.6	39.1	36.5	35.5	32.4	29.5	23.1			30
32	35.3	38.7	39.5	37.8	35.6	34.3	32.8	30.3	28.1	22.8			32
34		34.3	35.8	34.5	32.4	32.3	30.1	27.9	25.7	22.5	18.2		34
36		30.7	32.3	31.6	30	30	27.8	25.7	24.2	22.1	18	14.1	36
38		27.7	29.2	29.1	28	27.9	25.7	24.7	23.1	21.5	17.8	14.1	38
40		25.2	26.6	26.9	25.8	25.8	24.1	23.6	21.7	20.2	17.6	13.9	40
45		20.2	21.7	22.9	21.5	21.7	21.5	19.9	19	17.9	16.7	13.3	45
50			17.8	19.1	18	18.8	18.4	17.3	16.6	15.7	14.3	12.7	50
55			14.9	16.1	15.8	16.7	15.9	15.4	14.4	13.5	12.1	11.5	55
60				13.7	14	14.3	13.9	13.3	12.4	11.5	10.3	9.7	60
65				11.9	12.1	12.4	12.1	11.6	10.7	9.9	8.7	8.2	65
70				10.2	10.4	10.7	10.5	10	9.2	8.4	7.3	7	70
75					8.9	9.3	9	8.7	7.9	7.2	6.1	5.8	75
80					7.7	8.1	7.8	7.5	6.9	6.1	5.1	4.9	80
85					6.6	7	6.7	6.5	5.9	5.2	4.2	4	85
90						6	5.8	5.7	5	4.4	3.3	3.2	90
95						5.2	4.9	4.8	4.3	3.6	2.4	2.2	95
100							4.2	4.1	3.6	2.9			100
105							3.6	3.4	2.9	2.1			105
110							3	2.8	2.2				110
115								2.2					115

t_208_00325_00_000

Lifting capacities Forces de levage

T

ft	41 ft	54 ft	68 ft	82 ft	96 ft	110 ft	123 ft	137 ft	151 ft	165 ft	178 ft	190 ft	ft
10	139.5	139.5											10
11	139.5	139.5											11
12	137.5	139	131.1										12
13	131.7	131.8	124.6	106.3									13
14	121.6	121.8	114.1	101.4									14
15	111.9	112.8	102.5	95.2	83.7								15
16	103.4	103.3	94	86.6	77								16
17	96	94.3	86.9	78.7	73.2	64							17
18	89.4	86.2	79.1	71.8	68.1	61.6							18
19	82.9	78	72.5	68.6	63.2	57.3							19
20	75.8	71.3	66.6	63.7	58.5	53.1	47.7						20
22	63.4	61.1	59.1	55.1	50.9	47	43.5						22
24	53.7	53.1	51.4	48.5	44.8	41.5	39.4	35.3					24
26	45.1	46.4	45.3	42.8	39.8	38.2	36.1	33.1	29.9				26
28	38.2	41	40.2	38.2	36.2	35.5	32.5	29.9	27.5				28
30	32.9	36.2	36.1	34.4	32.7	32.2	29.5	27.9	25.3	23			30
32	28.6	32	32.5	31.2	29.7	29.3	27.5	26.3	24.2	22.2			32
34		28.2	29.5	28.7	27	26.9	25.6	24.2	22.3	20.4	18.2		34
36		25.2	26.7	27.4	24.7	24.6	24.3	22.3	21.2	19.5	17.8	14.1	36
38		22.6	24.3	25.2	22.7	23.1	22.5	20.9	19.8	18.7	16.9	14.1	38
40		20.4	22	23.3	20.8	22.1	20.8	19.9	18.6	17.2	15.6	13.9	40
45		16	17.6	18.9	18.5	18.4	17.3	16.5	15.3	14.1	12.7	12	45
50			14.1	15.5	15.5	15.3	14.4	13.7	12.7	11.6	10.3	9.7	50
55			11.4	12.8	12.9	13	12.1	11.5	10.6	9.7	8.4	7.9	55
60				10.6	10.7	10.9	10.2	9.7	8.8	8	6.8	6.4	60
65				8.8	8.9	9.1	8.7	8.2	7.4	6.6	5.5	5.2	65
70				7.3	7.5	7.7	7.4	6.9	6.2	5.4	4.3	4	70
75					6.2	6.6	6.3	5.8	5.1	4.4	3.1	2.8	75
80					5.2	5.6	5.3	4.9	4.2	3.4	2	1.8	80
85					4.3	4.7	4.4	4.1	3.3	2.3			85
90						3.9	3.5	3.3	2.3				90
95						3.2	2.7	2.5					95
100							1.9						100

t_208_00327_00_000

Lifting heights Hauteurs de levage

T

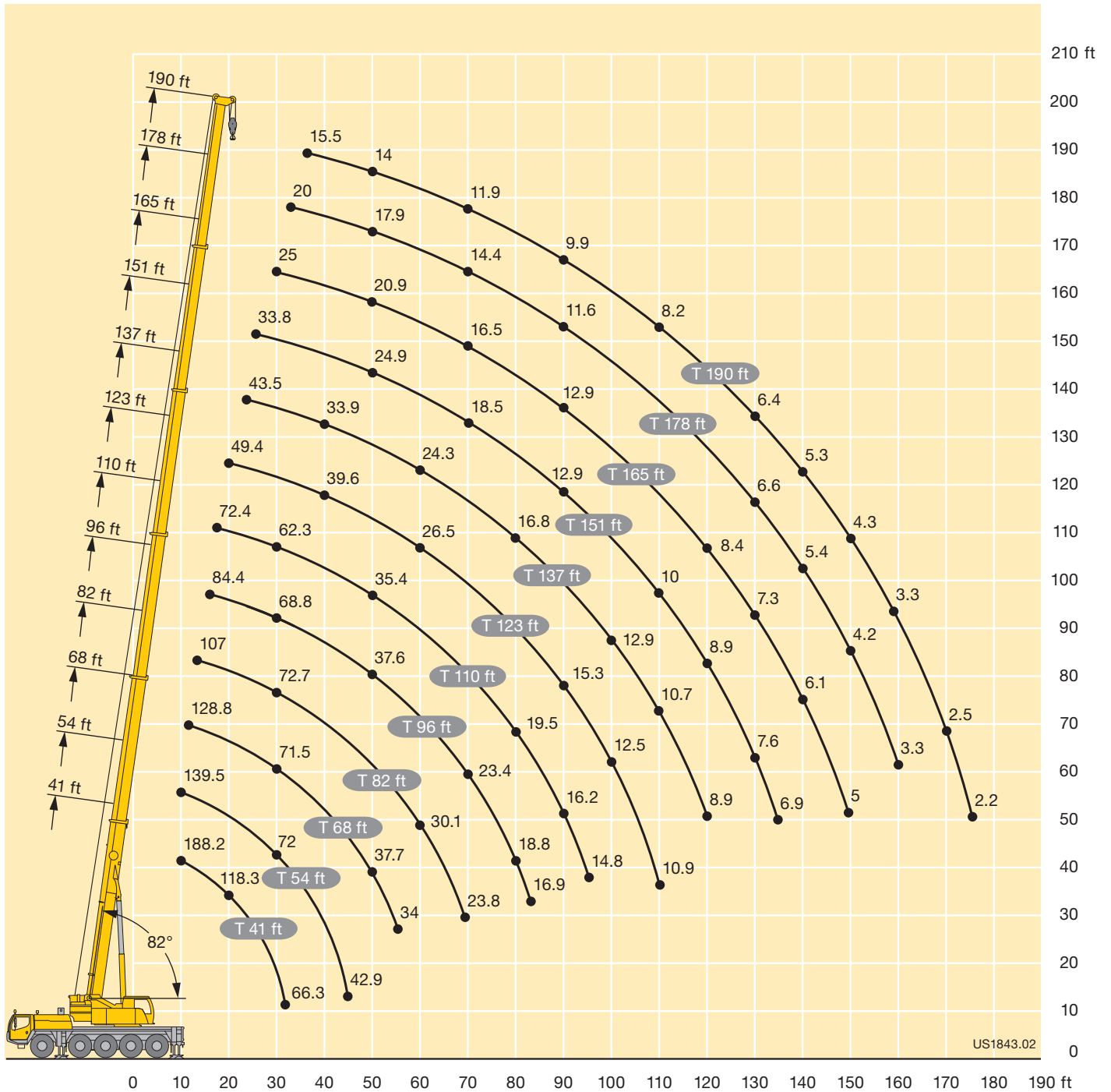

US1843.02

Lifting capacities Forces de levage

TK



ft	41 ft			96 ft			110 ft			123 ft			137 ft			151 ft			165 ft			178 ft			190 ft			ft
	34 ft			34 ft			34 ft			34 ft			34 ft			34 ft			34 ft			34 ft			34 ft			
	0°	20°	40°	0°	20°	40°	0°	20°	40°	0°	20°	40°	0°	20°	40°	0°	20°	40°	0°	20°	40°	0°	20°	40°	0°	20°	40°	
14	25																									14		
15	25	23																									15	
16	25	22.8		25																							16	
17	25	22.4		25																							17	
18	25	22		25																							18	
19	25	21.6		25			25																				19	
20	25	21.2		25			25																				20	
22	24.3	20.4		25			25																				22	
24	23.3	19.8	16.5	25			25			24.7																	24	
26	22.1	19.1	16.1	25			25			24.7		21															26	
28	20.9	18.6	15.8	25			25			24.7		20.9															28	
30	19.8	18	15.5	25	21.9		25			24.6		20.9		17.2													30	
32	18.9	17.5	15.2	25	21.5		25			24.4		20.8		17.1		12.5											32	
34	18.2	16.9	14.9	25	21		25	21		24.2		20.8		17.1		12.5			9.9								34	
36	17.4	16.2	14.7	25	20.6		25	20.6		23.9		20.7		17.1		12.5			9.9								36	
38	16.7	15.6	14.5	25	20.2	16.1	25	20.2		23.5	19.7	20.6		17.1		12.5			9.9						8.3		38	
40	16	15.1	14.2	25	19.9	15.9	24.9	19.9	15.9	23.2	19.4	20.5	18.4	17		12.5			9.9						8.2		40	
45	14.5	13.7	13.4	24.1	19	15.5	24	19.1	15.5	22.5	18.7	15.3	20.1	17.8	17	16.3	12.5	12.6	9.9						8.2		45	
50	13.1	12.6	12.4	22.5	18.2	15.1	22.9	18.3	15.1	21.7	18.1	15	19.6	17.3	14.6	16.8	15.9	12.4	12.3	9.9	9.7				8.2		50	
55	12	11.6	11.6	20.9	17.4	14.8	21.8	17.7	14.8	20.9	17.5	14.7	18.9	16.8	14.4	16	15.4	13.8	12.2	11.8	11.4	9.7	9.5		8.2		55	
60	11	10.9	11.1	19.4	16.6	14.5	20.5	17.1	14.5	20.2	16.9	14.4	18.1	16.4	14.1	15.3	14.7	13.6	11.8	11.3	11	9.4	9.2	9	8.1	8.1		60
65	10.2	10.4		18.2	15.7	14.2	19.2	16.3	14.3	19.3	16.3	14.2	17.1	15.9	14	14.5	13.9	13.4	11.4	10.8	10.5	9.1	8.9	8.7	8	7.9	7.9	65
70				17	14.9	13.8	18.1	15.5	14	18.3	15.7	14	16.1	15.3	13.7	13.7	13.1	12.9	10.9	10.3	10.1	8.9	8.6	8.4	7.8	7.7	7.6	70
75				16	14.2	13.2	17.1	14.8	13.6	17.4	15.1	13.7	15.1	14.7	13.4	12.9	12.4	12.2	10.4	9.9	9.7	8.6	8.3	8.2	7.6	7.5	7.4	75
80				15.1	13.5	12.7	16.1	14.2	13.1	15.8	14.4	13.3	14.1	14	13.1	12.1	11.7	11.6	9.8	9.5	9.3	8.2	8	7.9	7.4	7.3	7.2	80
85				14.2	12.8	12.3	15.3	13.5	12.7	14.5	13.9	12.9	13.2	13.2	12.7	11.4	11.1	11	9.3	9.1	9	7.9	7.7	7.6	7.2	7	7	85
90				13.5	12.3	11.9	14.4	13	12.3	13.5	13.4	12.5	12.2	12.3	12.2	10.7	10.5	10.4	8.9	8.8	8.6	7.6	7.4	7.4	6.9	6.8	6.7	90
95				12.8	11.8	11.6	13.1	12.5	11.9	12.3	12.6	12.2	11.1	11.6	11.7	10.1	10	9.9	8.6	8.4	8.3	7.3	7.2	7.1	6.7	6.5	6.5	95
100				12.1	11.4	11.3	12	12	11.6	11.2	11.8	11.7	10	10.7	11	9.6	9.5	9.5	8.2	8.1	8	7.1	6.9	6.9	6.4	6.3	6.3	100
105				11.6	11	11.1	10.9	11.3	11.4	10.2	10.8	11.3	9	9.7	10.2	8.7	9	9	7.8	7.7	7.7	6.8	6.7	6.6	6.2	6.1	6.1	105
110				10.9	10.7	11	9.9	10.4	10.6	9.3	9.9	10.3	8.5	8.7	9.2	7.9	8.5	8.7	7.5	7.4	7.5	6.5	6.4	6.4	5.9	5.9	5.9	110
115				10	10.2	10.2	9.1	9.4	9.5	8.5	9	9.3	8.1	8.1	8.3	7.1	7.7	8.1	7.1	7.1	7.2	6.3	6.2	6.2	5.7	5.7	5.7	115
120				9.2	9.3		8.3	8.6	8.8	7.7	8.1	8.4	7.4	7.7	7.7	6.7	6.9	7.3	6.5	6.8	6.9	6.1	6	6	5.5	5.5	5.5	120
125							7.5	7.8	7.8	6.9	7.3	7.5	6.7	7.2	7.4	6.4	6.4	6.6	5.9	6.4	6.6	5.8	5.8	5.8	5.2	5.2	5.3	125
130							6.8	7	6.9	6.2	6.5	6.6	6.1	6.5	6.7	6	6.1	6.2	5.5	5.8	6.1	5.5	5.6	5.6	5	5.1	5.1	130
135							6.2	6.2		5.5	5.8	5.8	5.4	5.8	6	5.5	5.8	5.9	5.2	5.3	5.5	4.9	5.3	5.4	4.6	4.9	4.9	135
140										4.9	5.1	5.1	4.8	5.2	5.3	5	5.4	5.5	5	5	5.1	4.4	4.8	5.2	4.2	4.6	4.7	140
145										4.4	4.5	4.3	4.3	4.6	4.6	4.4	4.8	5	4.7	4.8	4.9	3.9	4.3	4.6	3.7	4.2	4.4	145
150										3.7	4	4	4.2	4.2	4.4	4.3	4.6	4.7	4.3	4.6	4.7	3.5	3.8	4.1	3.3	3.7	3.9	150
155										3.3	3.4	3.4	4	4	4.1	3.9	4.2	4.3	3	3.4	3.6	2.8	3.2	3.5	2.8	3.2	3.5	155
160										2.9	2.9		3.8	3.8	3.9	3.4	3.7	3.8	2.6	3	3.1	2.4	2.8	3	2.4	2.8	3	160
165													3.4	3.6	3.6	3	3.2	3.3	2.2	2.5	2.7	2	2.4	2.6	2	2.4	2.6	165
170													3	3.1	3.1	2.6	2.8	2.8	1.7	2.1	2.2	1.6	2	2.2	1.6	2	2.2	170
175																2.7	2.7		2.2	2.4	2.4	1.6	1.7		1.5	1.7	175	
180																			1.8	2	1.9						180	
185																			1.5	1.6	1.5							185

t_208_61301_01_000 / 62301_01_000 / 63301_01_000

Lifting capacities Forces de levage

TK

41 - 190 ft
 62 ft
 T
 K
 360°
 50700 lbs
85%

ft	41 ft			96 ft			110 ft			123 ft			137 ft			151 ft			165 ft			178 ft			190 ft			ft
	62 ft			62 ft			62 ft			62 ft			62 ft			62 ft			62 ft			62 ft			62 ft			
	0°	20°	40°	0°	20°	40°	0°	20°	40°	0°	20°	40°	0°	20°	40°	0°	20°	40°	0°	20°	40°	0°	20°	40°	0°	20°	40°	
14	9.2																									14		
15	9.2																										15	
16	9.1																										16	
17	9.1																										17	
18	9																										18	
19	9																										19	
20	8.9																										20	
22	8.8																										22	
24	8.6			9.3																							24	
26	8.5			9.2																							26	
28	8.4			9.2			8.7																				28	
30	8.2	7.6		9.1			8.7			8																	30	
32	8.1	7.5		9			8.7			8																	32	
34	8	7.4		9			8.6			8		7.6															34	
36	7.8	7.2		8.9			8.5			8		7.5			7.6												36	
38	7.7	7.1		8.8			8.5			7.9		7.5			7.6												38	
40	7.5	7		8.7			8.4			7.9		7.5			7.6		7				5.9						40	
45	7	6.7	6	8.5	7.5		8.2			7.8		7.5			7.5		6.9				5.9						45	
50	6.4	6.4	5.9	8.2	7.2		8			7.7	7	7.4			7.5		6.9				5.9						50	
55	5.9	6.1	5.7	8	7		7.9	7		7.5	6.9	7.3	6.7		7.4		6.9				5.9			4.9			55	
60	5.4	5.7	5.6	7.8	6.8		7.7	6.8		7.4	6.7	7.2	6.6		7.3	6.7	6.8				5.9			4.9			60	
65	5	5.3	5.4	7.5	6.6		7.5	6.7	5.8	7.3	6.6	7.1	6.5		7.2	6.6	6.8	6.4			5.8			4.9			65	
70	4.6	4.9	5.2	7.2	6.5	5.8	7.3	6.5	5.7	7.1	6.5	5.7	7	6.4		7.1	6.5	6.7	6.3		5.8	5.8		4.8			70	
75	4.2	4.5	4.8	6.9	6.3	5.7	7	6.4	5.7	7	6.3	5.6	6.8	6.2	5.6	7	6.4	5.6	6.7	6.2		5.8	5.7		4.8	4.6	75	
80	4	4.1	4.4	6.5	6.1	5.6	6.7	6.2	5.6	6.8	6.1	5.5	6.7	6.1	5.5	6.9	6.2	5.5	6.6	6.1	5.4	5.8	5.6		4.7	4.6	80	
85	3.7	3.8	4	6.1	5.9	5.5	6.4	6.1	5.5	6.4	6	5.4	6.5	6	5.4	6.8	6.1	5.4	6.5	6	5.4	5.8	5.5	5.1	4.7	4.6	85	
90	3.5	3.5	3.7	5.8	5.6	5.4	6.1	5.8	5.4	6.1	5.8	5.4	6.3	5.8	5.3	6.7	6	5.4	6.4	5.9	5.3	5.7	5.5	5.1	4.6	4.6	4.9	90
95	3.3			5.5	5.4	5.3	5.8	5.6	5.4	5.8	5.6	5.3	6	5.6	5.3	6.6	5.9	5.3	6.3	5.8	5.2	5.6	5.4	5	4.6	4.6	4.8	95
100				5.2	5.1	5.1	5.5	5.3	5.2	5.5	5.4	5.3	5.7	5.5	5.2	6.4	5.8	5.3	6.2	5.7	5.2	5.5	5.3	5	4.5	4.6	4.8	100
105				4.9	4.8	4.8	5.3	5.1	5.1	5.2	5.2	5.1	5.5	5.3	5.1	6.3	5.7	5.2	6.1	5.6	5.2	5.4	5.2	5	4.5	4.6	4.7	105
110				4.7	4.6	4.6	5	4.9	4.9	5	4.9	4.9	5.2	5.1	5	6.2	5.6	5.2	6	5.5	5.1	5.2	5.1	4.9	4.5	4.6	4.5	110
115				4.4	4.4	4.4	4.8	4.7	4.7	4.7	4.7	4.8	5	4.9	4.8	6	5.5	5.2	5.9	5.4	5.1	5.1	4.9	4.8	4.4	4.5	4.4	115
120				4.2	4.2	4.2	4.6	4.5	4.5	4.5	4.5	4.6	4.7	4.7	4.7	5.7	5.5	5.1	5.8	5.4	5.1	4.9	4.8	4.7	4.4	4.4	4.3	120
125				4	4	4	4.4	4.3	4.3	4.2	4.3	4.4	4.5	4.5	4.5	5.5	5.3	5.1	5.6	5.3	5	4.7	4.6	4.6	4.3	4.3	4.2	125
130				3.8	3.8	3.9	4.2	4.1	4.2	4	4.1	4.2	4.3	4.3	4.4	5.3	5.2	5.1	5.4	5.2	5	4.6	4.5	4.5	4.2	4.2	4.1	130
135				3.7	3.7	3.8	4.1	4	4.1	3.8	3.9	4	4.1	4.2	4.2	5.1	5	5	5	5.1	5	4.4	4.4	4.4	4	4	4	135
140				3.5	3.5	3.7	3.9	3.9	3.9	3.6	3.7	3.8	4	4	4.1	4.9	4.9	4.9	4.6	4.9	4.9	4.2	4.2	4.2	3.9	3.9	3.9	140
145				3.4	3.4		3.7	3.7	3.8	3.5	3.5	3.6	3.8	3.8	3.9	4.6	4.7	4.8	4.1	4.8	4.8	4.1	4.1	4.1	3.7	3.8	3.8	145
150				3.3			3.6	3.6	3.7	3.3	3.4	3.5	3.6	3.7	3.8	4.4	4.5	4.6	3.9	4.4	4.7	3.8	4	4	3.5	3.6	3.7	150
155							3.5	3.5	3.7	3.2	3.2	3.3	3.5	3.5	3.6	4.1	4.3	4.4	3.7	4	4.5	3.4	3.8	3.9	3.1	3.5	3.6	155
160							3.4	3.4		3	3.1	3.1	3.3	3.3	3.4	3.7	4.1	4.3	3.6	3.6	4	3	3.7	3.8	2.7	3.4	3.5	160
165										2.9	2.9	3	3.2	3.2	3.3	3.3	3.9	4	3.4	3.5	3.6	2.6	3.3	3.6	2.3	3.1	3.3	165
170										2.8	2.8		3.1	3.1	3.2	3	3.5	3.7	3.1	3.4	3.4	2.2	2.9	3.3	2	2.7	3.1	170
175										2.7	2.7		2.9	3	3.1	2.9	3	3.2	2.7	3.2	3.3	1.9	2.5	2.9	1.6	2.3	2.7	175
180													2.8	2.9	3	2.8	2.9	2.9	2.4	2.9	3.1	1.5	2.1	2.5		1.9	2.4	180
185													2.7	2.8		2.5	2.7	2.7	2	2.5	2.7		1.8	2.1		1.5	2	185
190													2.6			2.3	2.5	2.5	1.7	2.1	2.3			1.7			1.6	190
195																2	2.2	2		1.8	1.9							195
200																1.7	1.8											200
205																1.5												205

t_208_65301_01_000 / 66301_01_000 / 67301_01_000

Lifting capacities Forces de levage

TK

41 – 190 ft

T

34 ft

K

360°

30000 lbs

85%

	41 ft			96 ft			110 ft			123 ft			137 ft			151 ft			165 ft			178 ft			190 ft				
	34 ft			34 ft			34 ft			34 ft			34 ft			34 ft			34 ft			34 ft							
	0°	20°	40°	0°	20°	40°	0°	20°	40°	0°	20°	40°	0°	20°	40°	0°	20°	40°	0°	20°	40°	0°	20°	40°	0°	20°	40°		
14	25																											14	
15	25	23																										15	
16	25	22.8		25																								16	
17	25	22.4		25																								17	
18	25	22		25																								18	
19	25	21.6		25			25																					19	
20	25	21.2		25			25																					20	
22	24.3	20.4		25			25																					22	
24	23.3	19.8	16.5	25			25			24.7																		24	
26	22.1	19.1	16.1	25			25			24.7		21																26	
28	20.9	18.6	15.8	25			25			24.7		20.9																28	
30	19.8	18	15.5	25	21.9		25			24.6		20.9		17.2														30	
32	18.9	17.5	15.2	25	21.5		25			24.4		20.8		17.1		12.5												32	
34	18.2	16.9	14.9	25	21		25	21		24.2		20.8		17.1		12.5			9.9									34	
36	17.4	16.2	14.7	25	20.6		25	20.6		23.9		20.7		17.1		12.5			9.9									36	
38	16.7	15.6	14.5	25	20.2	16.1	25	20.2		23.5	19.7	20.6		17.1		12.5			9.9							8.3		38	
40	16	15.1	14.2	25	19.9	15.9	24.9	19.9	15.9	23.2	19.4	20.5	18.4	17		12.5			9.9							8.2		40	
45	14.5	13.7	13.4	24.1	19	15.5	24	19.1	15.5	22.5	18.7	15.3	20.1	17.8	17	16.3	12.5	12.6	9.9							8.2		45	
50	13.1	12.6	12.4	22.5	18.2	15.1	22.9	18.3	15.1	21.7	18.1	15	19.6	17.3	14.6	16.8	15.9	12.4	12.3	9.9	9.7					8.2		50	
55	12	11.6	11.6	20.9	17.4	14.8	21.6	17.7	14.8	20.2	17.5	14.7	18.5	16.8	14.4	16	15.4	13.8	12.2	11.8	11.4	9.7	9.5			8.2		55	
60	11	10.9	11.1	19.4	16.6	14.5	19.2	17.1	14.5	18	16.9	14.4	16.5	16.4	14.1	15.3	14.7	13.6	11.8	11.3	11	9.4	9.2	9	8.1	8.1		60	
65	10.2	10.4		18.2	15.7	14.2	17	16.3	14.3	15.8	16.3	14.2	14.8	15.7	14	13.9	13.9	13.4	11.4	10.8	10.5	9.1	8.9	8.7	8	7.9	7.9	65	
70				16.4	14.9	13.8	15.1	15.5	14	14	15.2	14	13.5	13.9	13.7	12.3	13.1	12.9	10.9	10.3	10.1	8.9	8.6	8.4	7.8	7.7	7.6	70	
75				14.6	14.2	13.2	13.4	14.3	13.6	12.4	13.5	13.6	12	12.5	13	10.9	11.9	12.2	10.3	9.9	9.7	8.6	8.3	8.2	7.6	7.5	7.4	75	
80				13.2	13.5	12.7	11.9	12.9	13.1	10.9	11.9	12.7	10.6	11.5	11.7	10.2	10.5	11.3	9.5	9.5	9.3	8.2	8	7.9	7.4	7.3	7.2	80	
85				11.9	12.6	12.3	10.7	11.5	12.1	9.7	10.6	11.3	9.4	10.3	10.9	9.3	9.4	10.1	8.4	9	9	7.9	7.7	7.6	7.2	7	7	85	
90				10.7	11.3	11.8	9.5	10.3	10.8	8.6	9.4	10.1	8.3	9.1	9.8	8.2	8.9	8.9	7.8	8.3	8.6	7.4	7.4	7.4	6.9	6.8	6.7	90	
95				9.6	10.2	10.5	8.5	9.2	9.7	7.6	8.4	8.9	7.3	8.1	8.7	7.4	8.1	8.4	7.4	7.3	8	6.6	7.1	7.1	6.3	6.5	6.5	95	
100				8.6	9.1	9.3	7.7	8.2	8.6	6.7	7.4	7.9	6.4	7.2	7.7	7	7.2	7.8	6.8	6.9	7	5.8	6.6	6.9	5.6	6.3	6.3	100	
105				7.7	8.1	8.3	6.8	7.4	7.7	6	6.5	7	5.7	6.3	6.8	6.5	6.6	6.9	6	6.6	6.6	5	5.8	6.3	4.8	5.6	6.1	105	
110				6.9	7.2	7.3	6.1	6.5	6.8	5.7	5.8	6.1	5	5.5	6	5.9	6.3	6.4	5.3	5.9	6.3	4.4	5.1	5.6	4.1	4.9	5.4	110	
115				6.1	6.4	6.3	5.3	5.7	5.9	5.4	5.5	5.5	4.3	4.8	5.2	5.2	5.7	6	4.7	5.3	5.7	3.7	4.4	4.9	3.5	4.2	4.7	115	
120				5.5	5.6		4.6	5	5.1	5.1	5.2	5.2	3.7	4.2	4.5	4.6	5.1	5.5	4.1	4.6	5	3.2	3.8	4.2	3	3.6	4.1	120	
125							4	4.3	4.3	4.9	4.9	5	3.2	3.6	3.9	4.1	4.5	4.8	3.5	4.1	4.4	2.6	3.2	3.6	2.4	3	3.5	125	
130							3.4	3.6	3.5	4.6	4.7	4.7	2.7	3.1	3.3	3.6	4	4.3	3.1	3.5	3.8	1.9	2.7	3.1	1.7	2.5	2.9	130	
135							3	3		4.2	4.4	4.4	2.1	2.6	2.8	3.1	3.5	3.7	2.6	3	3.3	2	2.5		1.9	2.4	135		
140										3.7	3.9	3.9	1.5	1.9	2.1	2.7	3	3.2	2.1	2.6	2.8		1.4	1.9			1.7	140	
145										3.3	3.4	3.2				2.2	2.6	2.8	1.5	2.1	2.3							145	
150																1.7	2.1	2.2				1.5	1.8					150	
155																1.6	1.7												155

t_208_61312_01_000 / 62312_01_000 / 63312_01_000

Lifting capacities Forces de levage

TK



ft	41 ft			96 ft			110 ft			123 ft			137 ft			151 ft			165 ft			178 ft			190 ft			ft			
	62 ft			62 ft			62 ft			62 ft			62 ft			62 ft			62 ft			62 ft			62 ft						
	0°	20°	40°	0°	20°	40°	0°	20°	40°	0°	20°	40°	0°	20°	40°	0°	20°	40°	0°	20°	40°	0°	20°	40°	0°	20°	40°				
14	9.2																										14				
15	9.2																											15			
16	9.1																											16			
17	9.1																											17			
18	9																											18			
19	9																											19			
20	8.9																											20			
22	8.8																											22			
24	8.6			9.3																								24			
26	8.5			9.2																								26			
28	8.4			9.2			8.7																					28			
30	8.2	7.6		9.1			8.7			8																		30			
32	8.1	7.5		9			8.7			8																		32			
34	8	7.4		9			8.6			8		7.6																34			
36	7.8	7.2		8.9			8.5			8		7.5			7.6													36			
38	7.7	7.1		8.8			8.5			7.9		7.5			7.6													38			
40	7.5	7		8.7			8.4			7.9		7.5			7.6		7				5.9							40			
45	7	6.7	6	8.5	7.5		8.2			7.8		7.5			7.5		6.9				5.9							45			
50	6.4	6.4	5.9	8.2	7.2		8			7.7	7	7.4			7.5		6.9				5.9							50			
55	5.9	6.1	5.7	8	7		7.9	7		7.5	6.9	7.3	6.7		7.4		6.9				5.9				4.9			55			
60	5.4	5.7	5.6	7.8	6.8		7.7	6.8		7.4	6.7	7.2	6.6		7.3	6.7	6.8				5.9				4.9			60			
65	5	5.3	5.4	7.5	6.6		7.5	6.7	5.8	7.3	6.6	7.1	6.5		7.2	6.6	6.8	6.4			5.8				4.9			65			
70	4.6	4.9	5.2	7.2	6.5	5.8	7.3	6.5	5.7	7.1	6.5	5.7	7	6.4		7.1	6.5			6.7	6.3			5.8	5.8		4.8		70		
75	4.2	4.5	4.8	6.9	6.3	5.7	7	6.4	5.7	7	6.3	5.6	6.8	6.2	5.6	7	6.4	5.6		6.7	6.2			5.8	5.7		4.8	4.6	75		
80	4	4.1	4.4	6.5	6.1	5.6	6.7	6.2	5.6	6.8	6.1	5.5	6.7	6.1	5.5	6.9	6.2	5.5		6.6	6.1	5.4			5.8	5.6		4.7	4.6	80	
85	3.7	3.8	4	6.1	5.9	5.5	6.4	6.1	5.5	6.4	6	5.4	6.5	6	5.4	6.8	6.1	5.4		6.5	6	5.4			5.8	5.5	5.1	4.7	4.6	85	
90	3.5	3.5	3.7	5.8	5.6	5.4	6.1	5.8	5.4	6.1	5.8	5.4	6.3	5.8	5.3	6.7	6	5.4		6.4	5.9	5.3			5.7	5.5	5.1	4.6	4.6	4.9	90
95	3.3			5.5	5.4	5.3	5.8	5.6	5.4	5.8	5.6	5.3	6	5.6	5.3	6.6	5.9	5.3		6.3	5.8	5.2			5.6	5.4	5	4.6	4.6	4.8	95
100				5.2	5.1	5.1	5.5	5.3	5.2	5.5	5.4	5.3	5.7	5.5	5.2	6.4	5.8	5.3		6	5.7	5.2			5.5	5.3	5	4.5	4.6	4.8	100
105				4.9	4.8	4.8	5.3	5.1	5.1	5.2	5.2	5.1	5.5	5.3	5.1	6.2	5.7	5.2		5.5	5.6	5.2			5.3	5.2	5	4.5	4.6	4.7	105
110				4.7	4.6	4.6	5	4.9	4.9	5	4.9	4.9	5.2	5.1	5	5.5	5.6	5.2		5.3	5.5	5.1			4.7	5.1	4.9	4.4	4.6	4.5	110
115				4.4	4.4	4.4	4.8	4.7	4.7	4.7	4.7	4.8	5	4.9	4.8	5	5.5	5.2		4.9	5.2	5.1			4.1	4.9	4.8	3.8	4.5	4.4	115
120				4.2	4.2	4.2	4.6	4.5	4.5	4.5	4.5	4.6	4.7	4.7	4.7	4.8	5.4	5.1		4.4	4.8	5			3.5	4.6	4.7	3.2	4.3	4.3	120
125				4	4	4	4.4	4.3	4.3	4.2	4.3	4.4	4.5	4.5	4.5	4.5	4.8	5.1		3.9	4.7	4.8			3	4.1	4.6	2.7	3.8	4.2	125
130				3.8	3.8	3.9	4.2	4.1	4.2	4	4.1	4.2	4.3	4.3	4.4	4.1	4.4	5		3.4	4.3	4.5			2.4	3.6	4.3	2.1	3.3	4.1	130
135				3.7	3.7	3.8	4.1	4	4.1	3.8	3.9	4	4.1	4.2	4.2	3.6	4.3	4.4		2.9	3.8	4.3			1.9	3	3.8	1.6	2.8	3.7	135
140				3.5	3.5	3.7	3.9	3.9	3.9	3.6	3.7	3.8	3.9	4	4.1	3.2	3.9	4.2		2.5	3.3	4				2.6	3.3		2.4	3.2	140
145				3.4	3.4		3.7	3.7	3.8	3.5	3.5	3.6	3.6	3.8	3.9	2.8	3.5	4		2.1	2.9	3.5				2.1	2.8		1.8	2.7	145
150				3.3			3.6	3.6	3.7	3.3	3.4	3.5	3.2	3.6	3.8	2.4	3.1	3.5		1.6	2.5	3				1.5	2.4			2.2	150
155							3.5	3.5	3.7	3.1	3.2	3.3	2.8	3.3	3.5	2.1	2.7	3.1			2.1	2.6					1.8			1.6	155
160							3.3	3.4		2.8	3	3.1	2.4	2.9	3.1	1.6	2.3	2.6			1.6	2.2									160
165										2.4	2.7	2.7	2.1	2.5	2.7		1.9	2.2													165
170										2.1	2.3		1.7	2.1	2.2		1.4	1.8													170
175										1.9	1.9			1.7	1.8																175

t_208_65312_01_000 / 66312_01_000 / 67312_01_000

Lifting heights Hauteurs de levage

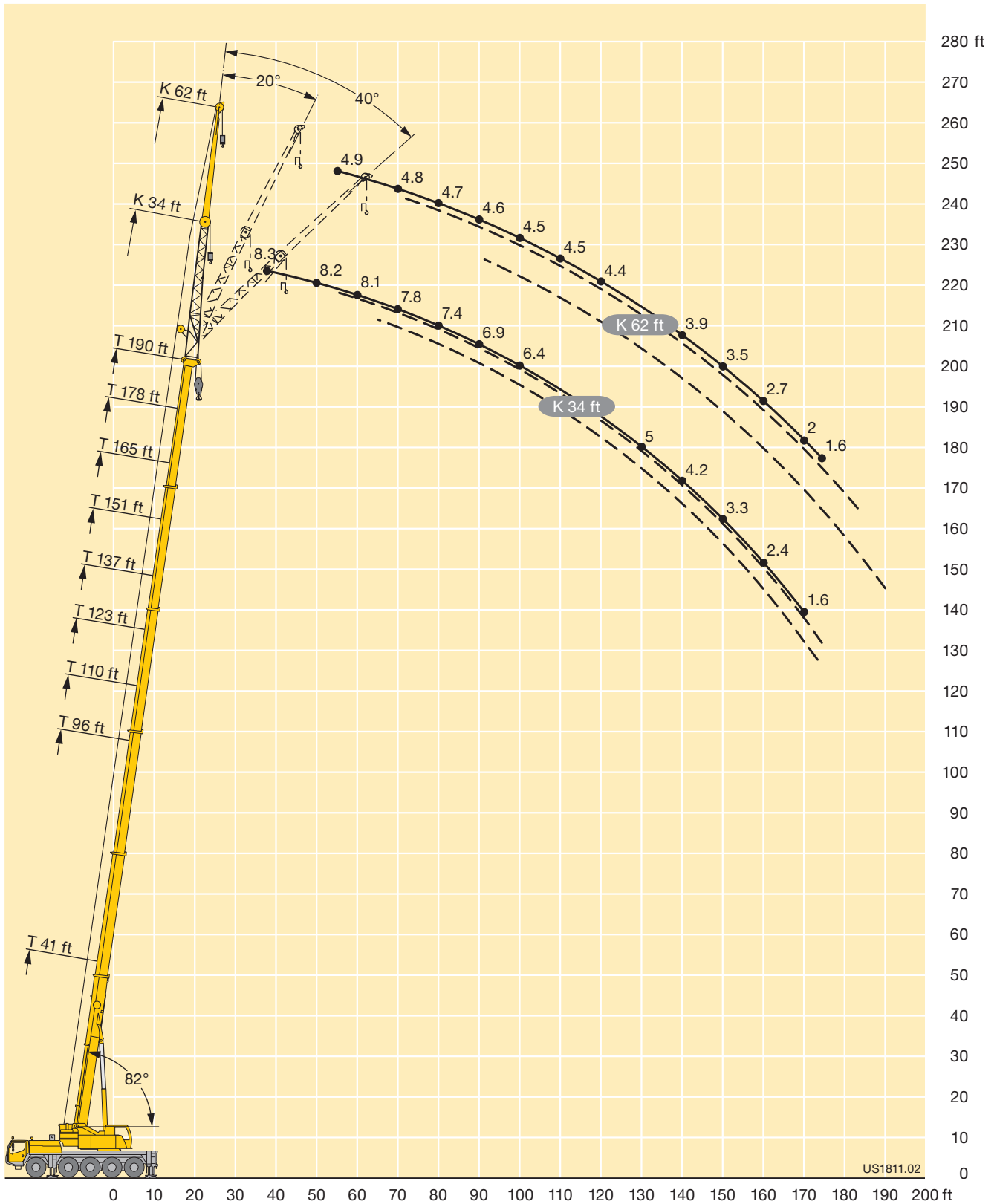

Lifting capacities Forces de levage

TVK



ft	41 ft + 23 ft			151 ft + 23 ft			165 ft + 23 ft			178 ft + 23 ft			190 ft + 23 ft			ft
	34 ft			34 ft			34 ft			34 ft			34 ft			
	0°	20°	40°	0°	20°	40°	0°	20°	40°	0°	20°	40°	0°	20°	40°	
11	7.8															11
12	7.8															12
13	7.8															13
14	7.8															14
15	7.8															15
16	7.8															16
17	7.8															17
18	7.8															18
19	7.8															19
20	7.8	7.8														20
22	7.7	7.8														22
24	7.5	7.8														24
26	7.3	7.7														26
28	7.1	7.4														28
30	6.8	7.2	7.1													30
32	6.6	7	7.1													32
34	6.3	6.7	7													34
36	6.1	6.5	6.8													36
38	5.9	6.2	6.6													38
40	5.6	6	6.3	7.8												40
45	5.1	5.5	5.7	7.8												45
50	4.6	5	5.3	7.8			7.1			6.4						50
55	4.2	4.6	4.9	7.8	7.6		7.1	7		6.4			5.4			55
60	3.8	4.1	4.4	7.6	7.3	7.1	7.1	6.7		6.4	6.4		5.3			60
65	3.4	3.7	4	7.3	6.8	6.8	7	6.6		6.4	6.3		5.2	5.4		65
70	3	3.3	3.5	7	6.7	6.5	6.8	6.4	6.5	6.3	6.2	6.2	5.2	5.3		70
75	2.6	2.9	3.1	6.7	6.5	6.2	6.6	6.2	6.3	6.2	5.9	6	5.1	5.2	5.3	75
80	2.4	2.5	2.7	6.4	6.2	6.1	6.4	6.1	6	6	5.8	5.8	5.1	5.1	5.2	80
85	2	2.2	2.2	6.1	5.9	5.9	6.2	5.9	5.8	5.8	5.6	5.6	5	5.1	5.1	85
90				5.8	5.7	5.6	5.9	5.7	5.6	5.6	5.4	5.5	5	5	4.9	90
95				5.6	5.5	5.4	5.7	5.5	5.4	5.4	5.2	5.2	4.9	4.8	4.8	95
100				5.3	5.3	5.3	5.5	5.3	5.2	5.2	5	5	4.7	4.6	4.6	100
105				5.1	5	5	5.2	5.1	5	5	4.8	4.8	4.6	4.5	4.4	105
110				4.8	4.8	4.8	5	4.9	4.9	4.8	4.7	4.7	4.4	4.4	4.3	110
115				4.6	4.5	4.6	4.8	4.7	4.7	4.7	4.5	4.6	4.2	4.2	4.2	115
120				4.4	4.3	4.4	4.6	4.5	4.5	4.5	4.4	4.5	4.1	4	4.1	120
125				4.2	4.2	4.2	4.4	4.3	4.4	4.3	4.3	4.3	3.9	3.9	3.9	125
130				4	4	4.1	4.2	4.1	4.2	4.1	4.2	4.2	3.8	3.7	3.7	130
135				3.8	3.7	3.9	4.1	4	4	4	4	4	3.6	3.5	3.6	135
140				3.6	3.6	3.7	3.9	3.8	3.9	3.8	3.8	3.8	3.4	3.4	3.5	140
145				3.4	3.4	3.5	3.7	3.7	3.7	3.6	3.7	3.7	3.3	3.3	3.4	145
150				3.2	3.2	3.4	3.6	3.5	3.6	3.1	3.4	3.6	2.9	3.2	3.2	150
155				3.1	3	3.2	3.4	3.4	3.4	2.7	3.1	3.4	2.5	2.9	3.1	155
160				2.9	2.9	3	3.1	3.2	3.3	2.3	2.7	3		2.5	2.8	160
165				2.7	2.8	2.8	2.8	3	3.1			2.3	2.6		2.4	165
170				2.6	2.6	2.7	2.4	2.8	2.9		1.9	2.1			2	170
175				2.4	2.5	2.5	2.1	2.4	2.5							175
180				2.2	2.3			2	2.1							180
185				1.9	2.1											185
190				1.6	1.7											190
195				1.3	1.4											195

t_208_71301_01_000 / 72301_01_000 / 73301_01_000

Lifting capacities Forces de levage

TVK



ft	41 ft + 23 ft			151 ft + 23 ft			165 ft + 23 ft			178 ft + 23 ft			188 ft + 23 ft			ft
	62 ft			62 ft			62 ft			62 ft			62 ft			
	0°	20°	40°	0°	20°	40°	0°	20°	40°	0°	20°	40°	0°	20°	40°	
14	5.1															14
15	5.1															15
16	5.1															16
17	5.1															17
18	5.1															18
19	5.1															19
20	5.1															20
22	5.1															22
24	5.1															24
26	5.1															26
28	5															28
30	5															30
32	5															32
34	5															34
36	4.9	4.7														36
38	4.8	4.7														38
40	4.8	4.7														40
45	4.5	4.6		5.1												45
50	4.2	4.5		5.1												50
55	3.9	4.2	4.2	5.1			4.4			3.9						55
60	3.6	4	4.1	5			4.4			3.9			2.9			60
65	3.4	3.7	4	5			4.4			3.9			2.9			65
70	3.2	3.4	3.8	5	4.7		4.4			3.9			2.9			70
75	2.9	3.2	3.5	4.9	4.7		4.4	4.4		3.9			2.9			75
80	2.7	2.9	3.2	4.8	4.6		4.4	4.4		3.9	3.9		2.9	2.9		80
85	2.4	2.7	3	4.7	4.5	4.2	4.4	4.3		3.9	3.9		2.8	2.9		85
90	2.2	2.5	2.8	4.6	4.3	4.2	4.4	4.2		3.9	3.9		2.8	2.9		90
95	2	2.2	2.5	4.4	4.2	4.1	4.3	4.1	4	3.8	3.9		2.8	2.9		95
100	1.7	2	2.2	4.3	4.1	4	4.2	4	3.9	3.8	3.8	3.7	2.7	2.9	2.9	100
105	1.5	1.7	1.9	4.1	3.9	3.9	4.1	3.9	3.8	3.7	3.7	3.7	2.7	2.9	2.9	105
110	1.3	1.5	1.4	3.9	3.8	3.8	3.9	3.8	3.7	3.7	3.7	3.6	2.7	2.8	2.9	110
115				3.8	3.7	3.7	3.8	3.7	3.7	3.6	3.6	3.5	2.6	2.8	2.9	115
120				3.6	3.5	3.6	3.7	3.6	3.5	3.5	3.5	3.5	2.6	2.8	2.9	120
125				3.4	3.4	3.4	3.5	3.4	3.4	3.4	3.4	3.4	2.6	2.8	2.9	125
130				3.3	3.3	3.2	3.4	3.3	3.3	3.3	3.3	3.3	2.5	2.8	2.9	130
135				3.2	3.2	3.2	3.2	3.2	3.2	3.2	3.2	3.2	2.5	2.8	2.9	135
140				3	3	3.1	3.1	3.1	3.1	3.1	3.1	3.1	2.5	2.7	2.8	140
145				2.9	2.9	3	2.9	3	3	3	3	3	2.5	2.7	2.7	145
150				2.7	2.8	2.9	2.8	2.9	2.9	2.9	2.9	2.9	2.4	2.5	2.6	150
155				2.6	2.7	2.8	2.7	2.8	2.8	2.7	2.8	2.8	2.4	2.5	2.6	155
160				2.5	2.6	2.6	2.6	2.6	2.7	2.5	2.7	2.7	2.3	2.4	2.5	160
165				2.4	2.5	2.5	2.5	2.5	2.6	2.2	2.6	2.6		2.3	2.4	165
170				2.2	2.3	2.4	2.4	2.4	2.5	1.8	2.4	2.5		2.2	2.3	170
175				2.1	2.2	2.3	2.2	2.3	2.4		2.2	2.4		2.1	2.2	175
180				2	2.1	2.1	2	2.2	2.3			2.2			2.1	180
185					2	2		2.1	2.2							185
190					1.9	1.9		1.9	2.1							190
195						1.8			1.9							195

t_208_75301_01_000 / 76301_01_000 / 77301_01_000

Lifting capacities Forces de levage

TVK



ft	41 ft + 23 ft			151 ft + 23 ft			165 ft + 23 ft			178 ft + 23 ft			190 ft + 23 ft			ft
	34 ft			34 ft			34 ft			34 ft			34 ft			
	0°	20°	40°	0°	20°	40°	0°	20°	40°	0°	20°	40°	0°	20°	40°	
11	7.8															11
12	7.8															12
13	7.8															13
14	7.8															14
15	7.8															15
16	7.8															16
17	7.8															17
18	7.8															18
19	7.8															19
20	7.8	7.8														20
22	7.7	7.8														22
24	7.5	7.8														24
26	7.3	7.7														26
28	7.1	7.4														28
30	6.8	7.2	7.1													30
32	6.6	7	7.1													32
34	6.3	6.7	7													34
36	6.1	6.5	6.8													36
38	5.9	6.2	6.6													38
40	5.6	6	6.3	7.8												40
45	5.1	5.5	5.7	7.8												45
50	4.6	5	5.3	7.8			7.1			6.4						50
55	4.2	4.6	4.9	7.8	7.6		7.1	7		6.4			5.4			55
60	3.8	4.1	4.4	7.6	7.3	7.1	7.1	6.7		6.4	6.4		5.3			60
65	3.4	3.7	4	7.3	6.8	6.8	7	6.6		6.4	6.3		5.2	5.4		65
70	3	3.3	3.5	7	6.7	6.5	6.8	6.4	6.5	6.3	6.2	6.2	5.2	5.3		70
75	2.6	2.9	3.1	6.7	6.5	6.2	6.6	6.2	6.3	6.2	5.9	6	5.1	5.2	5.3	75
80	2.4	2.5	2.7	6.4	6.2	6.1	6.4	6.1	6	6	5.8	5.8	5.1	5.1	5.2	80
85	2	2.2	2.2	6.1	5.9	5.9	6.2	5.9	5.8	5.8	5.6	5.6	5	5.1	5.1	85
90				5.8	5.7	5.6	5.9	5.7	5.6	5.6	5.4	5.5	5	5	4.9	90
95				5.6	5.5	5.4	5.7	5.5	5.4	5.4	5.2	5.2	4.9	4.8	4.8	95
100				5.3	5.3	5.3	5.5	5.3	5.2	5.2	5	5	4.7	4.6	4.6	100
105				5.1	5	5	5.2	5.1	5	4.8	4.8	4.8	4.3	4.5	4.4	105
110				4.8	4.8	4.8	5	4.9	4.9	4.1	4.7	4.7	3.8	4.3	4.3	110
115				4.6	4.5	4.6	4.4	4.7	4.7	3.5	4.1	4.5	3.2	3.8	4.2	115
120				4.4	4.3	4.4	3.8	4.3	4.5	2.9	3.5	4	2.6	3.3	3.8	120
125				3.9	4.2	4.2	3.3	3.8	4.2	2.3	3	3.4	2	2.7	3.2	125
130				3.4	3.9	4.1	2.8	3.3	3.7	1.6	2.4	2.9	1.3	2.1	2.7	130
135				3	3.4	3.7	2.3	2.8	3.1		1.8	2.3		1.5	2.1	135
140				2.5	3	3.2	1.7	2.3	2.6		1.2	1.7			1.5	140
145				2.1	2.5	2.8	1.2	1.8	2.2							145
150				1.6	2.1	2.3		1.3	1.6							150
155					1.6	1.8										155
160						1.3										160

t_208_71312_01_000 / 72312_01_000 / 73312_01_000

Lifting capacities Forces de levage

TVK



ft	41 ft + 23 ft			151 ft + 23 ft			165 ft + 23 ft			178 ft + 23 ft			188 ft + 23 ft			ft
	62 ft			62 ft			62 ft			62 ft			62 ft			
	0°	20°	40°	0°	20°	40°	0°	20°	40°	0°	20°	40°	0°	20°	40°	
14	5.1															14
15	5.1															15
16	5.1															16
17	5.1															17
18	5.1															18
19	5.1															19
20	5.1															20
22	5.1															22
24	5.1															24
26	5.1															26
28	5															28
30	5															30
32	5															32
34	5															34
36	4.9	4.7														36
38	4.8	4.7														38
40	4.8	4.7														40
45	4.5	4.6		5.1												45
50	4.2	4.5		5.1												50
55	3.9	4.2	4.2	5.1			4.4			3.9						55
60	3.6	4	4.1	5			4.4			3.9			2.9			60
65	3.4	3.7	4	5			4.4			3.9			2.9			65
70	3.2	3.4	3.8	5	4.7		4.4			3.9			2.9			70
75	2.9	3.2	3.5	4.9	4.7		4.4	4.4		3.9			2.9			75
80	2.7	2.9	3.2	4.8	4.6		4.4	4.4		3.9	3.9		2.9	2.9		80
85	2.4	2.7	3	4.7	4.5	4.2	4.4	4.3		3.9	3.9		2.8	2.9		85
90	2.2	2.5	2.8	4.6	4.3	4.2	4.4	4.2		3.9	3.9		2.8	2.9		90
95	2	2.2	2.5	4.4	4.2	4.1	4.3	4.1	4	3.8	3.9		2.8	2.9		95
100	1.7	2	2.2	4.3	4.1	4	4.2	4	3.9	3.8	3.8	3.7	2.7	2.9	2.9	100
105	1.5	1.7	1.9	4.1	3.9	3.9	4.1	3.9	3.8	3.7	3.7	3.7	2.7	2.9	2.9	105
110	1.3	1.5	1.4	3.9	3.8	3.8	3.9	3.8	3.7	3.7	3.7	3.6	2.7	2.8	2.9	110
115				3.8	3.7	3.7	3.8	3.7	3.7	3.6	3.6	3.5	2.6	2.8	2.9	115
120				3.6	3.5	3.6	3.7	3.6	3.5	3.1	3.5	3.5	2.6	2.8	2.9	120
125				3.4	3.4	3.4	3.4	3.4	3.4	2.6	3.4	3.4	2.3	2.8	2.9	125
130				3.3	3.3	3.2	3	3.3	3.3	2	3.1	3.3	2	2.7	2.9	130
135				3.1	3.2	3.2	2.5	3.2	3.2	1.5	2.8	3.2	1.4	2.6	2.9	135
140				2.8	3	3.1	2.1	3.1	3.1		2.3	2.9		2.1	2.8	140
145				2.4	2.9	3	1.5	2.6	3		1.7	2.6		1.6	2.5	145
150				2	2.7	2.9		2.2	2.8			2.1			2	150
155				1.6	2.4	2.7		1.7	2.4			1.6			1.5	155
160					2	2.5			1.9							160
165					1.6	2.1			1.4							165
170						1.6										170

t_208_75312_01_000 / 76312_01_000 / 77312_01_000

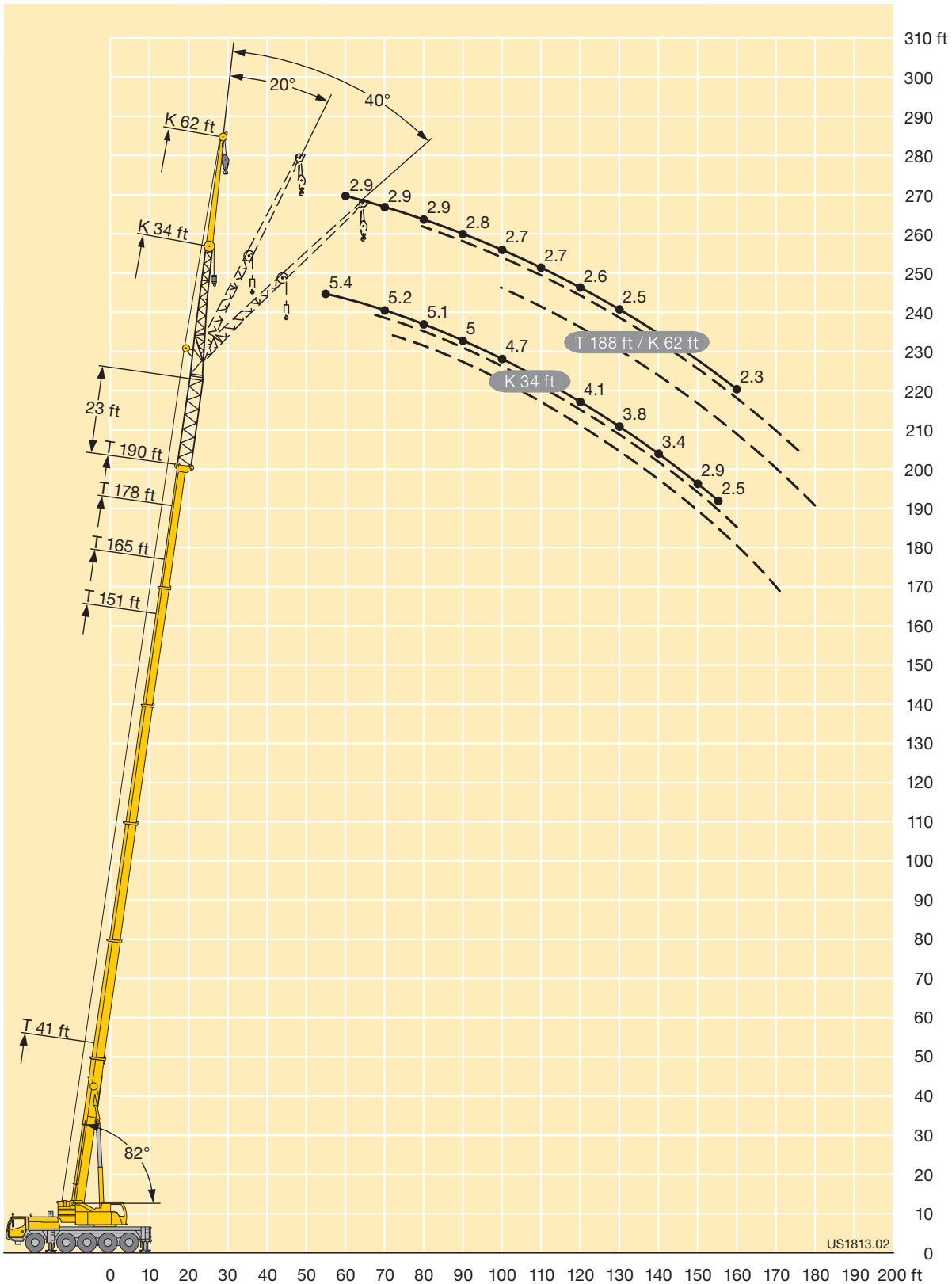

Lifting capacities Forces de levage

TNZK



ft	41 ft			96 ft			110 ft			123 ft			137 ft			151 ft			165 ft			178 ft			190 ft			ft
	34 ft			34 ft			34 ft			34 ft			34 ft			34 ft			34 ft			34 ft						
	0°	20°	40°	0°	20°	40°	0°	20°	40°	0°	20°	40°	0°	20°	40°	0°	20°	40°	0°	20°	40°	0°	20°	40°	0°	20°	40°	
13	25																									13		
14	25																									14		
15	25																									15		
16	25																									16		
17	25	22.3		25																						17		
18	25	21.8		25																						18		
19	25	21.4		25																						19		
20	25	21		25			25																			20		
22	24.4	20.3		25			25																			22		
24	23.3	19.7	16.4	25			25			24.7																24		
26	22.2	19	16.1	25			25			24.7		21														26		
28	21.1	18.5	15.7	25			25			24.7		20.9														28		
30	20	17.9	15.4	25	21.7		25			24.5		20.9		17.2												30		
32	19.1	17.4	15.1	25	21.3		25			24.4		20.9		17.1												32		
34	18.3	16.8	14.9	25	20.8		25	20.8		24.1		20.8		17.1			12.5									34		
36	17.4	16.2	14.6	25	20.4	16.2	25	20.4		23.8	19.9	20.7		17.1			12.5			9.9						36		
38	16.6	15.6	14.4	25	20.1	16	25	20.1		23.5	19.6	20.6		17.1			12.5			9.9						38		
40	15.9	15.1	14.2	25	19.7	15.8	24.9	19.7	15.8	23.2	19.3	20.5	18.3	17			12.5			9.9			8.2			40		
45	14.4	13.7	13.4	24	18.8	15.4	23.9	18.9	15.4	22.4	18.6	20	17.7	17			12.5			9.9			8.2			45		
50	13.1	12.6	12.4	22.4	18.1	15	22.8	18.2	15.1	21.6	18	14.9	19.5	17.2	14.6	16.8	15.8			9.8			8.2			50		
55	12	11.7	11.6	20.8	17.3	14.7	21.6	17.6	14.7	20.9	17.4	14.6	18.9	16.7	14.3	16	15.4	13.7		9.6	9.5		8.2	8.2		55		
60	11.1	10.9		19.3	16.5	14.4	20.3	17	14.5	20.1	16.8	14.4	18.1	16.3	14.1	15.3	14.7	13.6	11.8	11.3	11	9.4	9.2	9	8.1	8.1	60	
65	10.3	10.4		18.1	15.6	14.1	19	16.2	14.2	19.2	16.2	14.2	17.1	15.8	13.9	14.5	13.9	13.3	11.3	10.8	10.5	9.1	8.9	8.7	8	7.9	65	
70				16.9	14.9	13.7	18	15.5	13.9	18.2	15.6	14	16.1	15.3	13.7	13.7	13.1	12.8	10.9	10.3	10	8.8	8.6	8.4	7.8	7.7	7.6	70
75				15.9	14.2	13.2	17	14.8	13.6	17.3	15	13.7	15.1	14.7	13.4	12.9	12.4	12.2	10.4	9.8	9.6	8.6	8.3	8.2	7.6	7.5	7.4	75
80				15	13.5	12.7	16	14.1	13.1	15.9	14.4	13.3	14.1	14	13.1	12.1	11.7	11.6	9.8	9.5	9.3	8.2	8	7.9	7.4	7.2	7.2	80
85				14.2	12.8	12.2	15.2	13.5	12.7	14.5	13.8	12.9	13.2	13.2	12.7	11.4	11.1	11	9.3	9.1	8.9	7.9	7.7	7.6	7.2	7	7	85
90				13.5	12.3	11.9	14.3	12.9	12.3	13.6	13.3	12.5	12.2	12.3	12.2	10.7	10.5	10.4	8.9	8.8	8.6	7.6	7.4	7.4	6.9	6.8	6.7	90
95				12.8	11.8	11.5	13.1	12.4	11.9	12.3	12.6	12.2	11.1	11.6	11.7	10.1	10	9.9	8.5	8.4	8.3	7.3	7.2	7.1	6.7	6.5	6.5	95
100				12.1	11.4	11.3	12	12	11.6	11.2	11.9	11.7	10	10.7	11	9.6	9.5	9.5	8.2	8.1	8	7.1	6.9	6.9	6.4	6.3	6.3	100
105				11.6	11	11.1	10.9	11.3	11.4	10.2	10.8	11.3	9	9.7	10.2	8.8	9	9	7.8	7.7	7.7	6.8	6.6	6.6	6.2	6.1	6.1	105
110				10.9	10.7		9.9	10.4	10.6	9.4	9.9	10.3	8.5	8.8	9.2	7.9	8.5	8.7	7.5	7.4	7.5	6.5	6.4	6.4	5.9	5.9	5.9	110
115				10	10.2		9.2	9.4	9.5	8.5	9	9.3	8.1	8.1	8.3	7.1	7.7	8.2	7.1	7.1	7.2	6.3	6.2	6.2	5.7	5.7	5.7	115
120							8.3	8.7		7.7	8.2	8.4	7.4	7.7	7.7	6.7	6.9	7.4	6.5	6.8	6.9	6	6	6	5.5	5.4	5.5	120
125							7.5	7.8		6.9	7.3	7.5	6.7	7.2	7.4	6.4	6.4	6.6	5.9	6.4	6.6	5.8	5.8	5.8	5.2	5.2	5.3	125
130							6.8	7		6.2	6.5	6.6	6.1	6.5	6.7	6	6.1	6.2	5.5	5.8	6.1	5.5	5.6	5.6	5	5	5.1	130
135										5.5	5.8		5.4	5.8	6	5.5	5.8	5.9	5.2	5.3	5.5	4.9	5.3	5.4	4.7	4.8	4.9	135
140										4.9	5.1		4.8	5.2	5.3	5	5.4	5.5	5	5	5.1	4.4	4.9	5.2	4.2	4.6	4.7	140
145										4.4			4.3	4.6	4.6	4.4	4.8	5	4.7	4.8	4.9	3.9	4.4	4.6	3.7	4.2	4.4	145
150													3.8	4		4.2	4.2	4.4	4.3	4.6	4.7	3.5	3.8	4.1	3.3	3.7	3.9	150
155													3.3	3.4		4	4	4.1	3.9	4.2	4.3	3	3.4	3.6	2.8	3.3	3.5	155
160																3.8	3.8		3.4	3.7	3.8	2.6	3	3.2	2.4	2.8	3	160
165																3.4	3.6		3	3.2	3.3	2.2	2.5	2.7	2	2.4	2.6	165
170																3	3.1			2.6	2.8		2.1	2.2	2	2.2	170	
175																			2.2	2.4							175	
180																				1.8	2							180

t_208_64301_01_000

Lifting capacities Forces de levage

TNZK



ft	41 ft			96 ft			110 ft			123 ft			137 ft			151 ft			165 ft			178 ft			190 ft			ft		
	62 ft			62 ft			62 ft			62 ft			62 ft			62 ft			62 ft			62 ft			62 ft					
	0°	20°	40°	0°	20°	40°	0°	20°	40°	0°	20°	40°	0°	20°	40°	0°	20°	40°	0°	20°	40°	0°	20°	40°	0°	20°	40°			
13	9.3																									13				
14	9.2																										14			
15	9.2																										15			
16	9.1																										16			
17	9.1																										17			
18	9																										18			
19	9																										19			
20	8.9																										20			
22	8.8																										22			
24	8.6			9.3																							24			
26	8.5			9.2			8.8																				26			
28	8.3			9.2			8.7																				28			
30	8.2	7.3		9.1			8.7		8																		30			
32	8.1	7.3		9			8.7		8																		32			
34	7.9	7.3		8.9			8.6		8		7.6																34			
36	7.8	7.2		8.9			8.5		8		7.5			7.6													36			
38	7.7	7.1		8.8			8.5		7.9		7.5			7.6													38			
40	7.5	6.9		8.7			8.4		7.9		7.5			7.6		7											40			
45	7	6.7		8.4			8.2		7.8		7.5			7.5		6.9											45			
50	6.4	6.4	5.9	8.2	7.2		8		7.7		7.4			7.5		6.9					5.9						50			
55	5.9	6.1	5.7	8	7		7.8	7	7.7	6.8	7.5	6.8	7.3		7.4					6.9				5.9		4.9	55			
60	5.4	5.8	5.6	7.8	6.8		7.7	6.8	7.4	6.7	7.4	6.7	7.2	6.6	7.3	6.7				6.8				5.9		4.9	60			
65	5	5.3	5.4	7.5	6.6		7.5	6.6	7.2	6.6	7.1	6.5	7.1	6.5	7.2	6.6				6.8				5.8		4.9	65			
70	4.6	4.9	5.2	7.2	6.5	5.7	7.3	6.5	5.7	7.1	6.4	6.9	6.3	7.1	6.5	6.7	6.2			6.8	6.2			5.8		4.8	70			
75	4.2	4.5	4.8	6.9	6.3	5.7	7	6.3	5.6	7	6.3	5.6	6.8	6.2	5.5	7	6.3			6.6	6.1			5.8	5.7	4.8	4.6	75		
80	3.9	4.2	4.4	6.5	6.1	5.6	6.7	6.2	5.6	6.8	6.1	5.5	6.7	6.1	5.4	6.9	6.2	5.5		6.6	6	5.4		5.8	5.6	4.7	4.6	80		
85	3.7	3.8	4	6.1	5.9	5.5	6.4	6	5.5	6.4	6	5.4	6.5	5.9	5.4	6.8	6.1	5.4		6.5	5.9	5.3		5.8	5.5	5.1	4.7	4.6	85	
90	3.4	3.6		5.8	5.6	5.4	6.1	5.8	5.4	6.1	5.8	5.4	6.3	5.8	5.3	6.7	6	5.4		6.4	5.9	5.3		5.8	5.5	5.1	4.6	4.6	90	
95				5.5	5.4	5.3	5.8	5.6	5.3	5.8	5.6	5.3	6	5.6	5.3	6.5	5.9	5.3		6.3	5.8	5.2		5.6	5.4	5	4.6	4.6	4.8	95
100				5.2	5.1	5.1	5.5	5.4	5.2	5.5	5.4	5.2	5.7	5.5	5.2	6.4	5.8	5.3		6.2	5.7	5.2		5.5	5.3	5	4.5	4.6	4.8	100
105				4.9	4.8	4.8	5.3	5.1	5.1	5.2	5.2	5.1	5.5	5.3	5.1	6.3	5.7	5.2		6.1	5.6	5.2		5.4	5.2	5	4.5	4.6	4.7	105
110				4.7	4.6	4.6	5	4.9	4.9	4.9	5	4.9	5.2	5.1	5	6.2	5.6	5.2		6	5.5	5.1		5.2	5.1	4.9	4.5	4.6	4.6	110
115				4.4	4.4	4.4	4.8	4.7	4.7	4.7	4.8	4.8	5	4.9	4.8	6	5.5	5.2		5.9	5.4	5.1		5.1	4.9	4.8	4.4	4.5	4.4	115
120				4.2	4.2	4.2	4.6	4.5	4.5	4.5	4.5	4.6	4.7	4.7	4.7	5.8	5.5	5.1		5.7	5.4	5.1		4.9	4.8	4.7	4.4	4.4	4.3	120
125				4	4	4.1	4.4	4.3	4.3	4.2	4.3	4.4	4.5	4.5	4.5	5.5	5.3	5.1		5.6	5.3	5.1		4.7	4.6	4.6	4.3	4.3	4.2	125
130				3.8	3.8	3.9	4.2	4.1	4.2	4.1	4.1	4.2	4.3	4.3	4.4	5.3	5.2	5.1		5.4	5.2	5.1		4.6	4.5	4.5	4.2	4.1	4.1	130
135				3.7	3.7		4	4	4.1	3.9	3.9	4	4.1	4.2	4.2	5.1	5	5		5	5.1	5		4.4	4.3	4.4	4	4	4	135
140				3.5	3.5		3.9	3.9	3.9	3.7	3.7	3.8	4	4	4.1	4.9	4.9	4.9		4.6	4.9	5		4.3	4.2	4.3	3.9	3.9	3.9	140
145				3.4			3.7	3.7	3.8	3.5	3.6	3.6	3.8	3.8	3.9	4.7	4.7	4.8		4.1	4.8	4.8		4.1	4.1	4.1	3.7	3.8	3.8	145
150							3.6	3.6		3.3	3.4	3.5	3.6	3.7	3.8	4.4	4.5	4.6		3.9	4.4	4.7		3.8	3.9	4	3.5	3.6	3.7	150
155							3.5	3.5		3.2	3.2	3.3	3.5	3.5	3.6	4.1	4.3	4.4		3.8	4	4.5		3.4	3.8	3.9	3.1	3.5	3.6	155
160										3	3.1		3.3	3.4	3.4	3.7	4.1	4.3		3.6	3.6	4		3	3.7	3.8	2.7	3.4	3.5	160
165										2.9	2.9		3.2	3.2	3.3	3.3	3.9	4		3.4	3.5	3.6		2.6	3.3	3.6	2.3	3.1	3.3	165
170										2.7	2.8		3.1	3.1	3.2	3	3.5	3.7		3.1	3.4	3.5		2.3	2.9	3.3	2	2.7	3.2	170
175													2.9	3		2.9	3	3.2		2.7	3.2	3.3		1.9	2.5	2.9		2.3	2.8	175
180													2.8	2.9		2.8	2.9	2.9		2.4	2.9	3.1			2.2	2.5		1.9	2.4	180
185													2.7			2.5	2.7			2	2.5	2.7			1.8	2.1		1.6	2	185
190													2.6			2.3	2.5			1.7	2.1	2.3				1.7				190
195																2	2.2					1.8	1.9							195
200																1.7														200

t_208_68301_01_000

Lifting capacities Forces de levage

TNZK



ft	41 ft			96 ft			110 ft			123 ft			137 ft			151 ft			165 ft			178 ft			190 ft			ft
	34 ft			34 ft			34 ft			34 ft			34 ft			34 ft			34 ft			34 ft			34 ft			
	0°	20°	40°	0°	20°	40°	0°	20°	40°	0°	20°	40°	0°	20°	40°	0°	20°	40°	0°	20°	40°	0°	20°	40°	0°	20°	40°	
13	25																									13		
14	25																										14	
15	25																										15	
16	25																										16	
17	25	22.3		25																							17	
18	25	21.8		25																							18	
19	25	21.4		25																							19	
20	25	21		25			25																				20	
22	24.4	20.3		25			25																				22	
24	23.3	19.7	16.4	25			25			24.7																	24	
26	22.2	19	16.1	25			25			24.7		21															26	
28	21.1	18.5	15.7	25			25			24.7		20.9															28	
30	20	17.9	15.4	25	21.7		25			24.5		20.9		17.2													30	
32	19.1	17.4	15.1	25	21.3		25			24.4		20.9		17.1													32	
34	18.3	16.8	14.9	25	20.8		25	20.8		24.1		20.8		17.1			12.5										34	
36	17.4	16.2	14.6	25	20.4	16.2	25	20.4	23.8	19.9		20.7		17.1			12.5			9.9							36	
38	16.6	15.6	14.4	25	20.1	16	25	20.1	23.5	19.6		20.6		17.1			12.5			9.9							38	
40	15.9	15.1	14.2	25	19.7	15.8	24.9	19.7	15.8	23.2	19.3	20.5	18.3	17			12.5			9.9			8.2				40	
45	14.4	13.7	13.4	24	18.8	15.4	23.9	18.9	15.4	22.4	18.6	20	17.7	17			12.5			9.9			8.2				45	
50	13.1	12.6	12.4	22.4	18.1	15	22.8	18.2	15.1	21.6	18	14.9	19.5	17.2	14.6	16.8	15.8	12.4	12.2	9.8			8.2				50	
55	12	11.7	11.6	20.8	17.3	14.7	21.6	17.6	14.7	20.1	17.4	14.6	18.5	16.7	14.3	16	15.4	13.7	12.2	11.8	9.6	9.5	8.2	8.2			55	
60	11.1	10.9		19.3	16.5	14.4	19.3	17	14.5	18.1	16.8	14.4	16.6	16.3	14.1	15.3	14.7	13.6	11.8	11.3	11	9.4	9.2	9	8.1	8.1		60
65	10.3	10.4		18.1	15.6	14.1	17	16.2	14.2	15.9	16.2	14.2	14.8	15.7	13.9	13.9	13.9	13.3	11.3	10.8	10.5	9.1	8.9	8.7	8	7.9		65
70				16.4	14.9	13.7	15.1	15.5	13.9	14	15.1	14	13.5	14	13.7	12.3	13.1	12.8	10.9	10.3	10	8.8	8.6	8.4	7.8	7.7	7.6	70
75				14.7	14.2	13.2	13.4	14.3	13.6	12.4	13.5	13.6	12	12.5	13	10.9	11.9	12.2	10.3	9.8	9.6	8.6	8.3	8.2	7.6	7.5	7.4	75
80				13.2	13.5	12.7	12	12.9	13.1	11	12	12.7	10.6	11.5	11.7	10.2	10.5	11.3	9.6	9.5	9.3	8.2	8	7.9	7.4	7.2	7.2	80
85				11.9	12.6	12.2	10.7	11.5	12.1	9.7	10.6	11.4	9.4	10.3	10.9	9.3	9.4	10.1	8.4	9	8.9	7.9	7.7	7.6	7.2	7	7	85
90				10.7	11.3	11.8	9.6	10.3	10.8	8.6	9.4	10.1	8.3	9.2	9.9	8.3	8.9	8.9	7.7	8.3	8.6	7.4	7.4	7.4	6.9	6.8	6.7	90
95				9.7	10.2	10.5	8.6	9.2	9.7	7.6	8.4	9	7.3	8.1	8.7	7.4	8.1	8.4	7.4	7.3	8	6.7	7.1	7.1	6.3	6.5	6.5	95
100				8.7	9.1	9.3	7.7	8.2	8.6	6.8	7.4	7.9	6.5	7.2	7.7	7	7.2	7.8	6.8	6.9	7	5.8	6.6	6.9	5.6	6.3	6.3	100
105				7.7	8.1	8.3	6.8	7.4	7.7	6.1	6.5	7	5.7	6.3	6.8	6.5	6.7	6.9	6	6.6	6.7	5.1	5.8	6.3	4.8	5.6	6.1	105
110				6.9	7.2		6.1	6.5	6.8	5.8	5.8	6.2	5	5.6	6	5.9	6.3	6.4	5.3	6	6.3	4.4	5.1	5.6	4.2	4.9	5.4	110
115				6.1	6.4		5.3	5.7	5.9	5.4	5.4	5.5	4.3	4.9	5.2	5.2	5.8	6	4.7	5.3	5.7	3.8	4.4	4.9	3.5	4.2	4.7	115
120							4.6	5		5.1	5.2	5.2	3.7	4.2	4.6	4.6	5.1	5.5	4.1	4.6	5	3.2	3.8	4.2	3	3.6	4.1	120
125							4	4.3		4.9	4.9	5	3.2	3.6	3.9	4.1	4.5	4.8	3.6	4.1	4.4	2.6	3.2	3.6	2.4	3	3.5	125
130							3.4	3.6		4.6	4.7	4.7	2.7	3.1	3.3	3.6	4	4.3	3.1	3.5	3.8	2	2.7	3	1.7	2.5	2.9	130
135										4.2	4.4		2.1	2.6	2.8	3.1	3.5	3.7	2.6	3	3.3		2.1	2.5		1.9	2.4	135
140										3.7	3.9			1.9	2.1	2.7	3	3.2	2.1	2.6	2.8			1.9			1.7	140
145										3.3						2.3	2.6	2.8			2.1	2.3						145
150																1.8	2.1	2.3			1.8							150
155																		1.7										155

t_208_64312_01_000

Lifting capacities Forces de levage

TNZK



ft	41 ft			96 ft			110 ft			123 ft			137 ft			151 ft			165 ft			178 ft			190 ft			ft	
	62 ft			62 ft			62 ft			62 ft			62 ft			62 ft			62 ft			62 ft							
	0°	20°	40°	0°	20°	40°	0°	20°	40°	0°	20°	40°	0°	20°	40°	0°	20°	40°	0°	20°	40°	0°	20°	40°	0°	20°	40°		
13	9.3																										13		
14	9.2																											14	
15	9.2																											15	
16	9.1																											16	
17	9.1																											17	
18	9																											18	
19	9																											19	
20	8.9																											20	
22	8.8																											22	
24	8.6			9.3																								24	
26	8.5			9.2			8.8																					26	
28	8.3			9.2			8.7																					28	
30	8.2	7.3		9.1			8.7		8																			30	
32	8.1	7.3		9			8.7		8																			32	
34	7.9	7.3		8.9			8.6		8		7.6																	34	
36	7.8	7.2		8.9			8.5		8		7.5		7.6															36	
38	7.7	7.1		8.8			8.5		7.9		7.5		7.6															38	
40	7.5	6.9		8.7			8.4		7.9		7.5		7.6		7													40	
45	7	6.7		8.4			8.2		7.8		7.5		7.5		6.9													45	
50	6.4	6.4	5.9	8.2	7.2		8		7.7		7.4		7.5		6.9							5.9						50	
55	5.9	6.1	5.7	8	7		7.8	7	7.5	6.8		7.3		7.4		6.9						5.9			4.9			55	
60	5.4	5.8	5.6	7.8	6.8		7.7	6.8	7.4	6.7		7.2	6.6	7.3	6.7	6.8						5.9			4.9			60	
65	5	5.3	5.4	7.5	6.6		7.5	6.6	7.2	6.6		7.1	6.5	7.2	6.6	6.8						5.8			4.9			65	
70	4.6	4.9	5.2	7.2	6.5	5.7	7.3	6.5	5.7	7.1	6.4		6.9	6.3	7.1	6.5	6.7	6.2				5.8	6.2		4.8			70	
75	4.2	4.5	4.8	6.9	6.3	5.7	7	6.3	5.6	7	6.3	5.6	6.8	6.2	5.5	7	6.3	6.6	6.1			5.8	6.1		4.8	4.6		75	
80	3.9	4.2	4.4	6.5	6.1	5.6	6.7	6.2	5.6	6.8	6.1	5.5	6.7	6.1	5.4	6.9	6.2	5.5	6.6	6	5.4	5.8	5.6		4.7	4.6		80	
85	3.7	3.8	4	6.1	5.9	5.5	6.4	6	5.5	6.4	6	5.4	6.5	5.9	5.4	6.8	6.1	5.4	6.5	5.9	5.3	5.8	5.6	5.1	4.7	4.6		85	
90	3.4	3.6		5.8	5.6	5.4	6.1	5.8	5.4	6.1	5.8	5.4	6.3	5.8	5.3	6.7	6	5.4	6.4	5.9	5.3	5.8	5.5	5.1	4.6	4.6		90	
95				5.5	5.4	5.3	5.8	5.6	5.3	5.8	5.6	5.3	6	5.6	5.3	6.5	5.9	5.3	6.3	5.8	5.2	5.6	5.4	5	4.6	4.6	4.8	95	
100				5.2	5.1	5.1	5.5	5.4	5.2	5.5	5.4	5.2	5.7	5.5	5.2	6.4	5.8	5.3	6	5.7	5.2	5.5	5.3	5	4.5	4.6	4.8	100	
105				4.9	4.8	4.8	5.3	5.1	5.1	5.2	5.2	5.1	5.5	5.3	5.1	6.2	5.7	5.2	5.5	5.6	5.2	5.4	5.2	5	4.5	4.6	4.7	105	
110				4.7	4.6	4.6	5	4.9	4.9	4.9	5	4.9	5.2	5.1	5	5.6	5.6	5.2	5.3	5.5	5.1	4.7	5.1	4.9	4.4	4.6	4.6	110	
115				4.4	4.4	4.4	4.8	4.7	4.7	4.7	4.8	4.8	5	4.9	4.8	5	5.5	5.2	4.9	5.2	5.1	4.1	4.9	4.8	3.9	4.5	4.4	115	
120				4.2	4.2	4.2	4.6	4.5	4.5	4.5	4.5	4.6	4.7	4.7	4.7	4.8	5.4	5.1	4.4	4.8	5.1	3.5	4.6	4.7	3.3	4.3	4.3	120	
125				4	4	4.1	4.4	4.3	4.3	4.2	4.3	4.4	4.5	4.5	4.5	4.6	4.8	5.1	3.9	4.6	4.8	3	4.1	4.6	2.8	3.9	4.2	125	
130				3.8	3.8	3.9	4.2	4.1	4.2	4.1	4.1	4.2	4.3	4.3	4.4	4.1	4.4	4.9	3.4	4.3	4.5	2.5	3.6	4.3	2.2	3.4	4.1	130	
135				3.7	3.7		4	4	4.1	3.9	3.9	4	4.1	4.2	4.2	3.6	4.3	4.4	3	3.8	4.3	2	3.1	3.9	1.6	2.9	3.7	135	
140				3.5	3.5		3.9	3.9	3.9	3.7	3.7	3.8	3.9	4	4.1	3.2	3.9	4.2	2.5	3.4	4		2.6	3.3		2.4	3.2	140	
145				3.4			3.7	3.7	3.8	3.5	3.6	3.6	3.6	3.8	3.9	2.8	3.5	4	2.1	2.9	3.5		2.1	2.8		1.9	2.7	145	
150							3.6	3.6		3.3	3.4	3.5	3.2	3.6	3.8	2.4	3.1	3.5	1.6	2.5	3		1.6	2.4			2.2	150	
155							3.5	3.5		3.1	3.2	3.3	2.8	3.3	3.5	2.1	2.7	3.1		2.1	2.6			1.8			1.6	155	
160										2.8	3		2.4	2.9	3.1	1.6	2.3	2.7		1.6	2.2							160	
165										2.5	2.7		2.1	2.5	2.7		1.9	2.2			1.7							165	
170										2.1	2.3		1.7	2.1	2.2		1.5	1.8										170	
175										1.9				1.7															175

t_208_68312_01_000

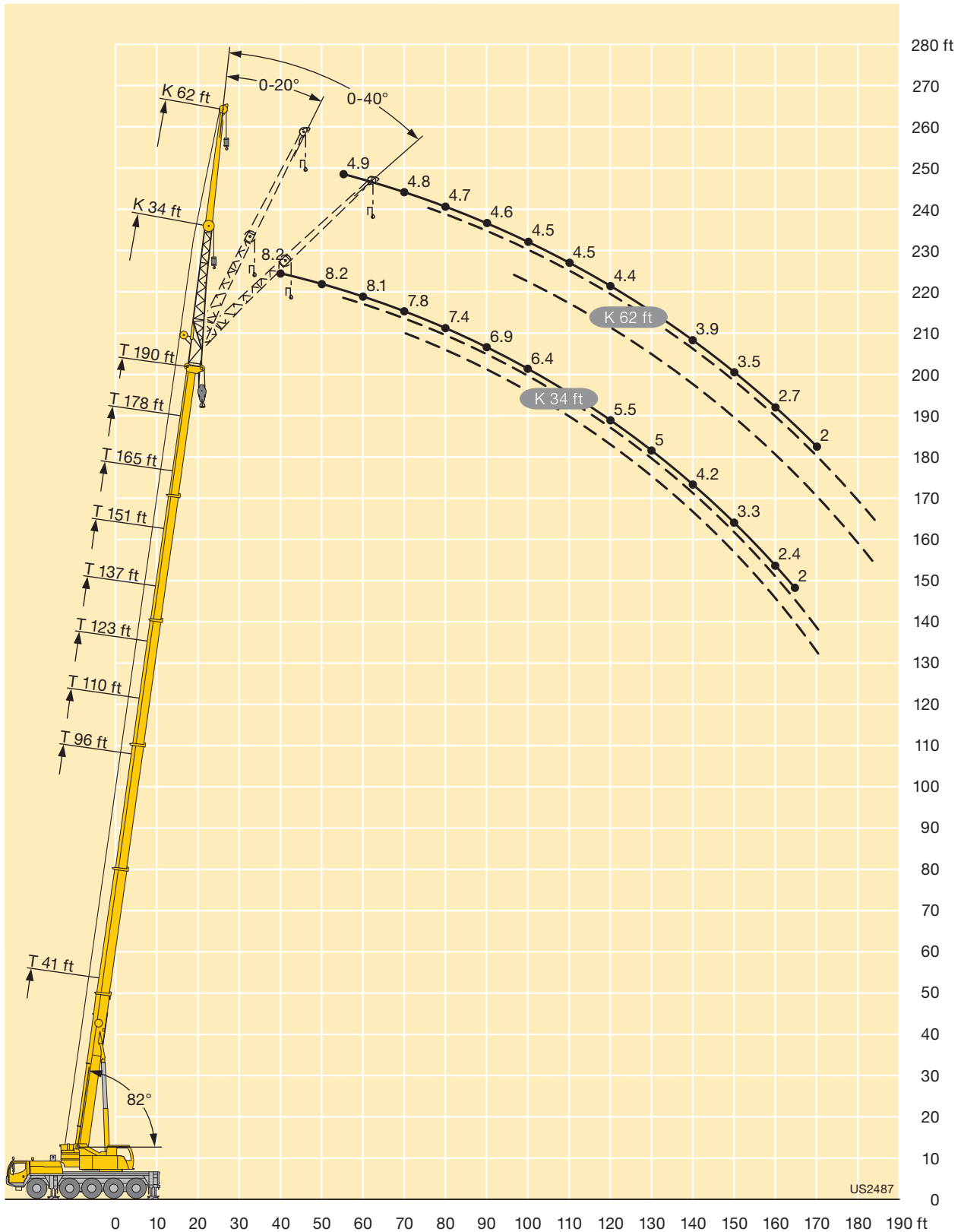

Lifting capacities Forces de levage

TVNZK



ft	41 ft + 23 ft			151 ft + 23 ft			165 ft + 23 ft			178 ft + 23 ft			190 ft + 23 ft			ft
	34 ft			34 ft			34 ft			34 ft			34 ft			
	0°	20°	40°	0°	20°	40°	0°	20°	40°	0°	20°	40°	0°	20°	40°	
12	7.8															12
13	7.8															13
14	7.8															14
15	7.8															15
16	7.8															16
17	7.8															17
18	7.8															18
19	7.8	7.8														19
20	7.8	7.8														20
22	7.6	7.8														22
24	7.5	7.8														24
26	7.3	7.6														26
28	7.1	7.4	7.1													28
30	6.9	7.2	7.1													30
32	6.6	7	7.1													32
34	6.4	6.7	7													34
36	6.1	6.4	6.8													36
38	5.8	6.2	6.6													38
40	5.5	6	6.3	7.8												40
45	4.8	5.5	5.7	7.8						6.4						45
50	4.5	5	5.3	7.8	7.8		7.1			6.4						50
55	4.2	4.6	4.9	7.8	7.6		7.1	7		6.4	6.4		5.4			55
60	3.8	4.1	4.4	7.6	7.3	7.1	7.1	6.8		6.4	6.4		5.3			60
65	3.4	3.7	4	7.3	6.9	6.9	7	6.6	6.6	6.4	6.3		5.2			65
70	3	3.3	3.5	7	6.7	6.5	6.8	6.4	6.5	6.3	6.2	6.2	5.2	5.3	5.4	70
75	2.7	2.9	3.1	6.6	6.5	6.3	6.6	6.2	6.3	6.2	6	6.1	5.1	5.2	5.3	75
80	2.3	2.5	2.8	6.3	6.2	6.1	6.4	6.1	6	6	5.8	5.8	5.1	5.1	5.2	80
85	2	2.2	2.5	6.1	5.9	5.9	6.2	5.9	5.8	5.9	5.6	5.6	5	5.1	5.1	85
90	1.7			5.8	5.7	5.6	5.9	5.7	5.6	5.7	5.4	5.5	5	5	4.9	90
95				5.5	5.5	5.4	5.7	5.5	5.4	5.5	5.2	5.2	4.9	4.8	4.8	95
100				5.3	5.3	5.3	5.5	5.3	5.2	5.2	5	5	4.7	4.6	4.6	100
105				5.1	5	5.1	5.2	5.1	5	5	4.8	4.8	4.6	4.5	4.4	105
110				4.8	4.8	4.8	5	4.9	4.9	4.8	4.7	4.7	4.4	4.4	4.3	110
115				4.6	4.5	4.6	4.8	4.7	4.7	4.7	4.5	4.6	4.2	4.2	4.2	115
120				4.4	4.4	4.4	4.6	4.5	4.5	4.5	4.4	4.5	4.1	4.1	4.1	120
125				4.2	4.2	4.2	4.4	4.3	4.4	4.3	4.3	4.3	3.9	3.9	3.9	125
130				4	4	4.1	4.2	4.1	4.2	4.2	4.2	4.2	3.8	3.7	3.7	130
135				3.8	3.7	3.9	4.1	4	4	4	4	4	3.6	3.5	3.6	135
140				3.6	3.6	3.7	3.9	3.8	3.9	3.8	3.9	3.8	3.4	3.4	3.5	140
145				3.4	3.4	3.6	3.7	3.7	3.7	3.6	3.7	3.7	3.3	3.3	3.4	145
150				3.2	3.2	3.4	3.6	3.5	3.6	3.2	3.4	3.6	2.9	3.2	3.2	150
155				3.1	3	3.2	3.4	3.4	3.4	2.8	3.1	3.4	2.5	2.9	3.1	155
160				2.9	2.9	3	3.2	3.2	3.3	2.4	2.8	3	2.1	2.6	2.8	160
165				2.7	2.8	2.8	2.9	3	3.1	2	2.4	2.6	1.7		2.4	165
170				2.6	2.6	2.7	2.5	2.8	2.9	1.5	2	2.2			2	170
175				2.4	2.5	2.5	2.1	2.4	2.5		1.5					175
180				2.2	2.3		1.7	2	2.1							180
185				2	2.1		1.3	1.6	1.7							185
190				1.6	1.8											190
195				1.3	1.4											195

t_208_74301_01_000

Lifting capacities Forces de levage

TVNZK



ft	41 ft + 23 ft			151 ft + 23 ft			165 ft + 23 ft			178 ft + 23 ft			188 ft + 23 ft			ft
	62 ft			62 ft			62 ft			62 ft			62 ft			
	0°	20°	40°	0°	20°	40°	0°	20°	40°	0°	20°	40°	0°	20°	40°	
15	5.1															15
16	5.1															16
17	5.1															17
18	5.1															18
19	5.1															19
20	5.1															20
22	5.1															22
24	5.1															24
26	5.1															26
28	5.1															28
30	5.1															30
32	5															32
34	4.9	4.7														34
36	4.9	4.7														36
38	4.9	4.7														38
40	4.8	4.7														40
45	4.5	4.6														45
50	4.2	4.5	4.2	5.1						4						50
55	3.9	4.3	4.2	5.1			4.4			3.9						55
60	3.7	4	4.2	5			4.4			3.9			2.9			60
65	3.4	3.7	4	5			4.4			3.9			2.9			65
70	3.2	3.5	3.8	5	4.7		4.4			3.9			2.9			70
75	3.1	3.2	3.5	4.9	4.7		4.4	4.4		3.9			2.9			75
80	2.9	3	3.2	4.8	4.6		4.4	4.4		3.9	3.9		2.9	2.9		80
85	2.7	2.7	3	4.7	4.5		4.4	4.3	4.1	3.9	3.9		2.8	2.9		85
90	2.5	2.5	2.8	4.6	4.4	4.2	4.4	4.2	4.1	3.9	3.9		2.8	2.9		90
95	2.3	2.2	2.5	4.5	4.3	4.1	4.3	4.1	4	3.8	3.9	3.7	2.8	2.9	2.9	95
100	2.2	1.9	2.2	4.3	4.1	4	4.2	4	3.9	3.8	3.8	3.7	2.7	2.9	2.9	100
105	2	1.8	1.9	4.1	4	3.9	4.1	3.9	3.8	3.7	3.7	3.7	2.7	2.9	2.9	105
110	1.8	1.7	1.8	4	3.8	3.8	4	3.8	3.7	3.7	3.7	3.6	2.7	2.9	2.9	110
115	1.6	1.7		3.8	3.7	3.7	3.8	3.7	3.7	3.6	3.6	3.5	2.6	2.8	2.9	115
120				3.6	3.6	3.6	3.7	3.6	3.6	3.5	3.5	3.5	2.6	2.8	2.9	120
125				3.5	3.4	3.4	3.5	3.4	3.4	3.4	3.4	3.4	2.6	2.8	2.9	125
130				3.3	3.3	3.3	3.4	3.3	3.3	3.3	3.3	3.3	2.5	2.8	2.9	130
135				3.2	3.2	3.2	3.2	3.2	3.2	3.2	3.2	3.2	2.5	2.8	2.9	135
140				3	3	3.1	3.1	3.1	3.1	3.1	3.1	3.1	2.5	2.7	2.8	140
145				2.9	2.9	3	3	3	3	3	3	3	2.5	2.7	2.7	145
150				2.7	2.8	2.9	2.8	2.9	2.9	2.9	2.9	2.9	2.4	2.5	2.7	150
155				2.6	2.7	2.8	2.7	2.8	2.8	2.7	2.8	2.8	2.4	2.5	2.6	155
160				2.5	2.6	2.6	2.6	2.6	2.7	2.6	2.7	2.7	2.3	2.4	2.5	160
165				2.4	2.5	2.5	2.5	2.5	2.6	2.3	2.6	2.6		2.3	2.4	165
170				2.3	2.3	2.4	2.4	2.4	2.5	1.9	2.4	2.5		2.2	2.3	170
175				2.1	2.2	2.3	2.2	2.3	2.4	1.5	2.3	2.4		2.1	2.2	175
180				2	2.1	2.1	2	2.2	2.3			2.3			2.1	180
185					2	2		2.1	2.2							185
190					1.9	1.9		1.9	2.1							190
195						1.8			1.9							195

t_208_78301_01_000

Lifting capacities Forces de levage

TVNZK



ft	41 ft + 23 ft			151 ft + 23 ft			165 ft + 23 ft			178 ft + 23 ft			190 ft + 23 ft			ft
	34 ft			34 ft			34 ft			34 ft			34 ft			
	0°	20°	40°	0°	20°	40°	0°	20°	40°	0°	20°	40°	0°	20°	40°	
12	7.8															12
13	7.8															13
14	7.8															14
15	7.8															15
16	7.8															16
17	7.8															17
18	7.8															18
19	7.8	7.8														19
20	7.8	7.8														20
22	7.6	7.8														22
24	7.5	7.8														24
26	7.3	7.6														26
28	7.1	7.4	7.1													28
30	6.9	7.2	7.1													30
32	6.6	7	7.1													32
34	6.4	6.7	7													34
36	6.1	6.4	6.8													36
38	5.8	6.2	6.6													38
40	5.5	6	6.3	7.8												40
45	4.8	5.5	5.7	7.8						6.4						45
50	4.5	5	5.3	7.8	7.8		7.1			6.4						50
55	4.2	4.6	4.9	7.8	7.6		7.1	7		6.4	6.4		5.4			55
60	3.8	4.1	4.4	7.6	7.3	7.1	7.1	6.8		6.4	6.4		5.3			60
65	3.4	3.7	4	7.3	6.9	6.9	7	6.6	6.6	6.4	6.3		5.2			65
70	3	3.3	3.5	7	6.7	6.5	6.8	6.4	6.5	6.3	6.2	6.2	5.2	5.3	5.4	70
75	2.7	2.9	3.1	6.6	6.5	6.3	6.6	6.2	6.3	6.2	6	6.1	5.1	5.2	5.3	75
80	2.3	2.5	2.8	6.3	6.2	6.1	6.4	6.1	6	6	5.8	5.8	5.1	5.1	5.2	80
85	2	2.2	2.5	6.1	5.9	5.9	6.2	5.9	5.8	5.9	5.6	5.6	5	5.1	5.1	85
90	1.7			5.8	5.7	5.6	5.9	5.7	5.6	5.7	5.4	5.5	5	5	4.9	90
95				5.5	5.5	5.4	5.7	5.5	5.4	5.5	5.2	5.2	4.9	4.8	4.8	95
100				5.3	5.3	5.3	5.5	5.3	5.2	5.2	5	5	4.7	4.6	4.6	100
105				5.1	5	5.1	5.2	5.1	5	4.8	4.8	4.8	4.4	4.5	4.4	105
110				4.8	4.8	4.8	5	4.9	4.9	4.1	4.7	4.7	3.9	4.3	4.3	110
115				4.6	4.5	4.6	4.4	4.7	4.7	3.5	4.2	4.5	3.3	3.9	4.2	115
120				4.4	4.4	4.4	3.8	4.4	4.5	2.9	3.6	4.1	2.7	3.4	3.8	120
125				4	4.2	4.2	3.3	3.8	4.2	2.4	3	3.5	2	2.8	3.3	125
130				3.5	3.9	4.1	2.8	3.3	3.7	1.7	2.5	2.9	1.4	2.2	2.7	130
135				3	3.5	3.7	2.3	2.8	3.2		1.9	2.4		1.6	2.1	135
140				2.6	3	3.3	1.7	2.3	2.7		1.3	1.7			1.5	140
145				2.1	2.6	2.8	1.3	1.8	2.2							145
150				1.6	2.1	2.4		1.3	1.6							150
155				1.2	1.6	1.9										155
160						1.3										160

t_208_74312_01_000

Lifting capacities Forces de levage

TVNZK



ft	41 ft + 23 ft			151 ft + 23 ft			165 ft + 23 ft			178 ft + 23 ft			188 ft + 23 ft			ft
	62 ft			62 ft			62 ft			62 ft			62 ft			
	0°	20°	40°	0°	20°	40°	0°	20°	40°	0°	20°	40°	0°	20°	40°	
15	5.1															15
16	5.1															16
17	5.1															17
18	5.1															18
19	5.1															19
20	5.1															20
22	5.1															22
24	5.1															24
26	5.1															26
28	5.1															28
30	5.1															30
32	5															32
34	4.9	4.7														34
36	4.9	4.7														36
38	4.9	4.7														38
40	4.8	4.7														40
45	4.5	4.6														45
50	4.2	4.5	4.2	5.1						4						50
55	3.9	4.3	4.2	5.1			4.4			3.9						55
60	3.7	4	4.2	5			4.4			3.9			2.9			60
65	3.4	3.7	4	5			4.4			3.9			2.9			65
70	3.2	3.5	3.8	5	4.7		4.4			3.9			2.9			70
75	3.1	3.2	3.5	4.9	4.7		4.4	4.4		3.9			2.9			75
80	2.9	3	3.2	4.8	4.6		4.4	4.4		3.9	3.9		2.9	2.9		80
85	2.7	2.7	3	4.7	4.5		4.4	4.3	4.1	3.9	3.9		2.8	2.9		85
90	2.5	2.5	2.8	4.6	4.4	4.2	4.4	4.2	4.1	3.9	3.9		2.8	2.9		90
95	2.3	2.2	2.5	4.5	4.3	4.1	4.3	4.1	4	3.8	3.9	3.7	2.8	2.9	2.9	95
100	2.2	1.9	2.2	4.3	4.1	4	4.2	4	3.9	3.8	3.8	3.7	2.7	2.9	2.9	100
105	2	1.8	1.9	4.1	4	3.9	4.1	3.9	3.8	3.7	3.7	3.7	2.7	2.9	2.9	105
110	1.8	1.7	1.8	4	3.8	3.8	4	3.8	3.7	3.7	3.7	3.6	2.7	2.9	2.9	110
115	1.6	1.7		3.8	3.7	3.7	3.8	3.7	3.7	3.6	3.6	3.5	2.6	2.8	2.9	115
120				3.6	3.6	3.6	3.7	3.6	3.6	3.2	3.5	3.5	2.6	2.8	2.9	120
125				3.5	3.4	3.4	3.5	3.4	3.4	2.7	3.4	3.4	2.4	2.8	2.9	125
130				3.3	3.3	3.3	3.1	3.3	3.3	2.1	3.2	3.3	2	2.7	2.9	130
135				3.1	3.2	3.2	2.6	3.2	3.2	1.5	2.8	3.2	1.5	2.6	2.9	135
140				2.9	3	3.1	2.1	3.1	3.1		2.3	3		2.2	2.8	140
145				2.5	2.9	3	1.6	2.7	3		1.8	2.7		1.7	2.5	145
150				2.1	2.7	2.9		2.2	2.9		1.3	2.2			2.1	150
155				1.6	2.4	2.8		1.8	2.4			1.6			1.5	155
160					2	2.5		1.3	2							160
165					1.6	2.1			1.5							165
170						1.7										170
175						1.2										175

t_208_78312_01_000

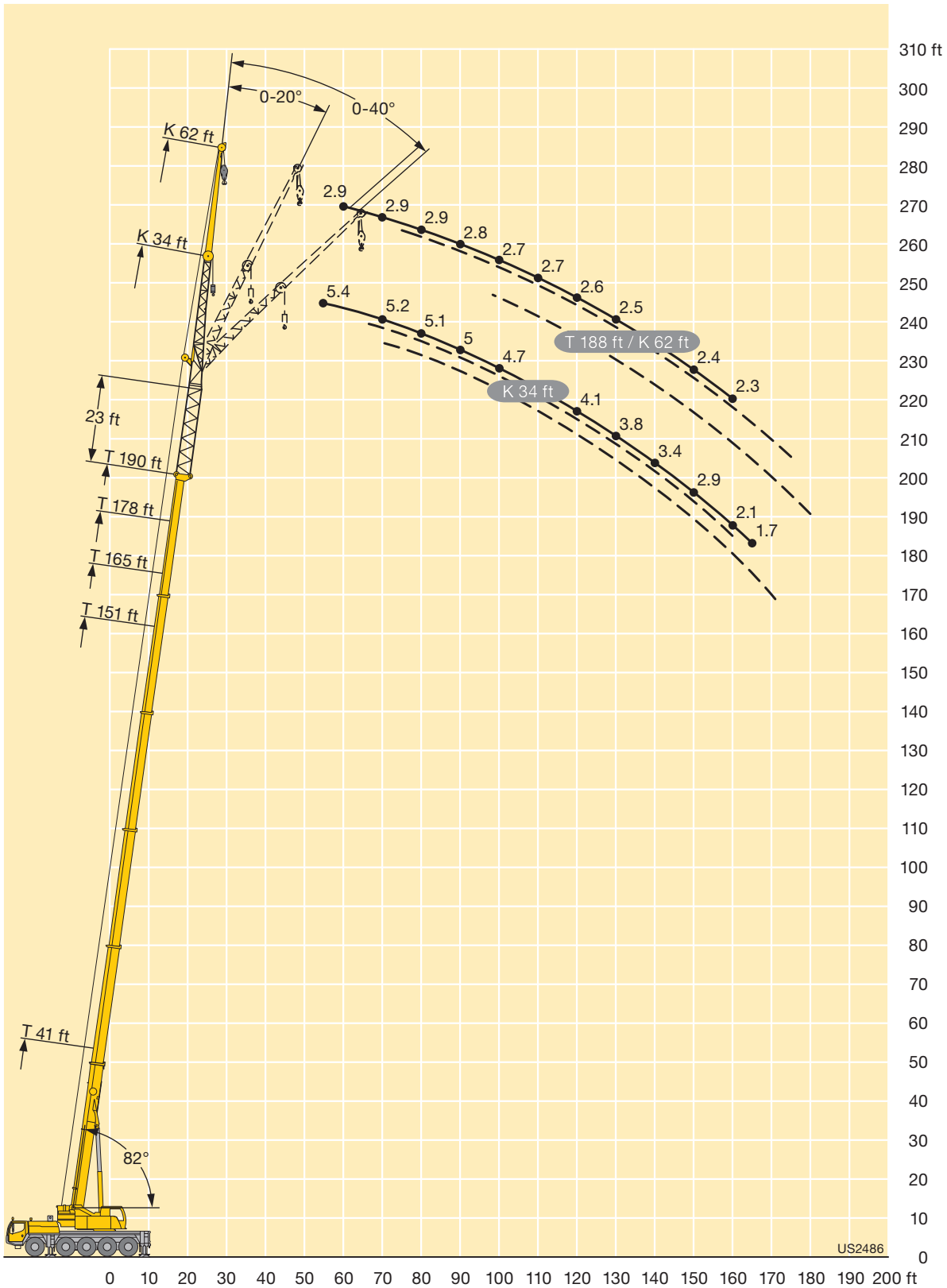

Lifting capacities Forces de levage

TK



ft	8 ft												ft
	41 ft	54 ft	68 ft	82 ft	96 ft	110 ft	123 ft	137 ft	151 ft	165 ft	178 ft	190 ft	
10	49.3	49.3											10
11	49.3	49.3											11
12	49.3	49.3	49.3										12
13	49.3	49.3	49.3	49.3									13
14	49.3	49.3	49.3	49.3									14
15	49.3	49.3	49.3	49.3									15
16	49.3	49.3	49.3	49.3									16
17	49.3	49.3	49.3	49.3	49.3								17
18	48.4	49.3	49.3	49.3	49.3								18
19	47	49.3	49.3	49.3	49.3								19
20	45.6	49.3	49.3	49.3	49.3	49.3							20
22	42.6	49.3	49.3	49.3	49.3	49.3							22
24	39.9	48.5	49.3	49.3	49.3	49.3	46.2						24
26	37.7	46	49.3	49.3	49.3	49.3	45	36.9					26
28	35.6	43.7	49	49.3	49.3	49.3	43.8	36.2					28
30	33.9	41.5	47.8	49.3	49.3	48.8	42.4	35.4	27.3				30
32	32.2	39.6	45.6	49.3	49.3	47	41.1	34.4	26.9				32
34	30.9	37.9	43.9	48.2	49.3	45	39.7	33.4	26.4	20.9			34
36	29.6	36.2	42.2	46.6	48.7	43	38.4	32.3	25.9	20.7	16.4		36
38	28.5	34.9	40.4	44.8	47.5	41.9	37.1	31.3	25.3	20.5	16.3		38
40		33.6	39	43.4	46.1	40.8	35.8	30.3	24.8	20.1	16.1	12.1	40
45		30.7	35.7	39.9	40.6	38.4	32.9	27.8	23.3	19.2	15.6	11.9	45
50		28.6	33.1	36.7	35.1	35	30.2	25.7	21.9	18.2	15	11.7	50
55			30.8	32.7	32.4	30.8	27.6	23.7	20.4	17.1	14.3	11.3	55
60			28.8	28.8	29.1	27.2	25.2	21.9	19.1	16.1	13.7	10.9	60
65			26	26.9	25.9	24.2	22.5	20.4	17.7	15.2	13	10.5	65
70				24.2	23.3	21.7	20.7	18.9	16.5	14.3	12.3	10.1	70
75				21.6	21.1	19.5	18.7	17.3	15.4	13.5	11.7	9.6	75
80					19	17.6	17.3	15.6	14.4	12.8	11.1	9.2	80
85					17	15.9	16.3	14	13.4	12	10.5	8.8	85
90					15.3	14.6	14.9	13.1	12.4	11.3	9.9	8.4	90
95						14	13.6	12.2	11.2	10.6	9.4	8	95
100						13.2	12.3	11.2	10.1	9.9	8.9	7.7	100
105						12	11.1	10.6	9.4	9.3	8.4	7.3	105
110							10.1	10.1	8.8	8.5	8	7	110
115							9.1	9.4	8.4	7.7	7.6	6.7	115
120								8.6	7.8	7.2	7.3	6.5	120
125								7.8	7.3	6.8	6.6	6.2	125
130								7.1	7	6.6	6	5.8	130
135									6.5	6.2	5.4	5.2	135
140									5.9	5.6	4.8	4.7	140
145										5	4.3	4.2	145
150										4.5	3.8	3.7	150
155										4	3.3	3.3	155
160										3.6	2.8	2.8	160
165											2.4	2.4	165
170											2	2	170

t_208_59301_01_000

Lifting capacities Forces de levage

TK



ft	8 ft												ft
	41 ft	54 ft	68 ft	82 ft	96 ft	110 ft	123 ft	137 ft	151 ft	165 ft	178 ft	190 ft	
10	49.3	49.3											10
11	49.3	49.3											11
12	49.3	49.3	49.3										12
13	49.3	49.3	49.3	49.3									13
14	49.3	49.3	49.3	49.3									14
15	49.3	49.3	49.3	49.3									15
16	49.3	49.3	49.3	49.3									16
17	49.3	49.3	49.3	49.3	49.3								17
18	48.4	49.3	49.3	49.3	49.3								18
19	47	49.3	49.3	49.3	49.3								19
20	45.6	49.3	49.3	49.3	49.3	49.3							20
22	42.6	49.3	49.3	49.3	49.3	49.3							22
24	39.9	48.5	49.3	49.3	49.3	49.3	46.2						24
26	37.7	46	49.3	49.3	49.3	49.3	45	36.9					26
28	35.6	43.7	49	49.3	49.3	49.3	43.8	36.2					28
30	33.9	41.5	47.8	49.3	49.3	48.8	42.4	35.4	27.3				30
32	32.2	39.6	45.6	49	48.5	45.4	41.1	34.4	26.9				32
34	30.9	37.9	43.9	47.1	44.8	43.9	39.7	33.4	26.4	20.9			34
36	29.6	36.2	42.2	44.4	41.6	41	37.9	32.3	25.9	20.7	16.4		36
38	28.5	34.9	40.3	41	40.3	38.2	35.5	31.3	25.3	20.5	16.3		38
40		33.6	38.5	38.2	37.9	35.4	33.1	30.3	24.8	20.1	16.1	12.1	40
45		30.7	33.9	33.8	32.2	30.1	28.7	26.9	23.3	19.2	15.6	11.9	45
50		28.5	29.5	29.3	27.7	26	24.7	23	21.9	18.2	15	11.7	50
55			26.4	25.5	24.1	22.6	22.5	20.9	19.4	17.1	14.3	11.3	55
60			22.9	22.4	21.1	20.4	19.8	18.3	16.9	16.1	13.7	10.9	60
65			19.9	19.9	18.6	18.9	17.5	16.1	15.3	14.8	13	10.5	65
70				17.5	16.5	16.8	15.5	14.8	14.2	13.1	12.3	10.1	70
75				15.4	14.9	15.1	13.8	13.7	12.7	11.8	11.5	9.6	75
80					13.2	13.5	12.8	12.3	11.4	11.1	10.5	9.2	80
85					11.6	12.1	11.9	11	10.7	10.2	9.2	8.7	85
90					10.3	10.7	11.1	9.9	9.7	9.2	8.2	8	90
95						9.6	9.9	9	8.7	8.2	7.2	7	95
100						8.9	8.9	8.5	8	7.3	6.3	6.2	100
105						8.4	8	7.9	7.2	6.5	5.5	5.4	105
110							7.2	7.2	6.5	5.8	4.8	4.7	110
115							6.6	6.5	5.8	5.2	4.2	4.1	115
120								5.8	5.2	4.5	3.6	3.5	120
125								5.2	4.6	4	3.1	2.9	125
130								4.5	4	3.5	2.5	2.4	130
135									3.4	3	2	1.8	135
140									2.9	2.5			140
145										2			145

t_208_59312_01_000

Lifting heights Hauteurs de levage

TK

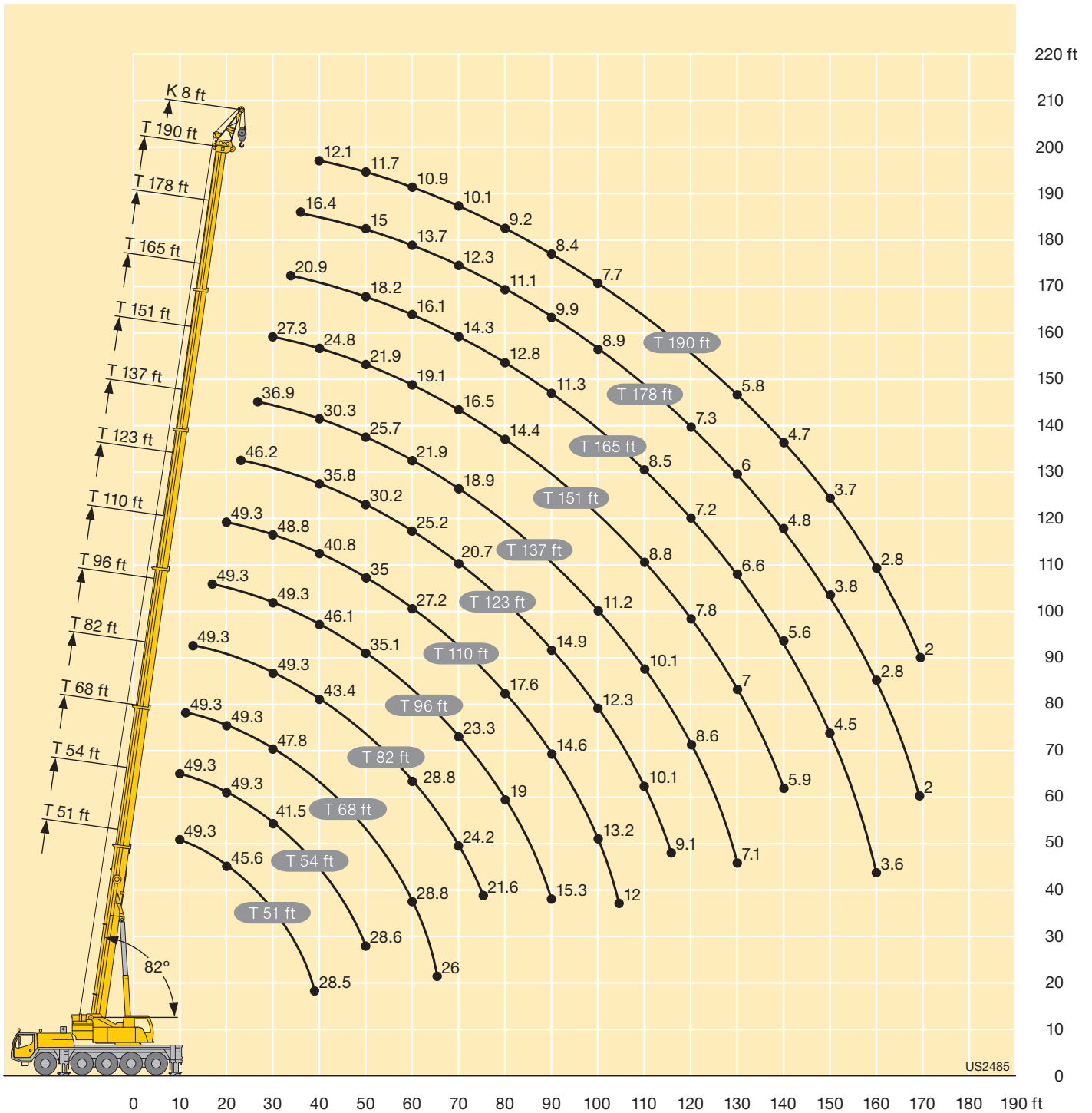

US2485

Equipment Equipment

Crane carrier

Frame	Self-manufactured, weight-optimized and torsion resistant box-type design of high-tensile structural steel.
Outriggers	4-point supporting system, hydraulically telescopic into horizontal and vertical direction. Operation with remote control, automatic support leveling, electronic inclination display.
Engine	6-cylinder Diesel, make Liebherr, watercooled, output 370 kW (503 h.p.), max. torque 1726 lbs-ft. Exhaust emissions acc. to 97/68/EG and EPA/CARB. Fuel reservoir: 129 gallons.
Transmission	ZF 12-speed gear box with automatic control system AS-TRONIC. ZF-intarder fitted directly to the gear. Two-stage transfer case with lockable transfer differential.
Axles	Low maintenance carrier axles, all 5 axles steered. Axle 2, 4 and 5 are equipped with planetary gears, all driven axles with transverse differential locks, axle 4 with longitudinal differential lock.
Suspension	All axles are mounted on hydropneumatic suspension and are lockable hydraulically.
Tyres	10 tyres, size: 445/95 R 25 (16.00 R 25).
Steering	2-circuit system with hydraulic servo steering. Active speed depending rear axle steering, special steering programs for various driving situations.
Brakes	Service brake: Dual circuit, all-wheel servo-air brake. Parking brake: Spring brake actuator acting on all the wheels of axles 1, 2, 3 and 4. Sustained-action brakes: Engine brake as exhaust retarder with Liebherr additional brake system ZBS. Intarder on gear.
Driver's cab	Spacious and comfortable sheet steel cab mounted on rubber shock absorbers, safety glass windows.
Electrical system	Control of the electrical and electronical components by modern data bus technique. 24 Volt DC, 2 batteries 170 Ah each.

Crane superstructure

Frame	Liebherr-manufactured, torsionally rigid steel construction made from high-tensile fine-grain steel. Triple-roller slewing rim.
Crane engine	4-cylinder Diesel, make Liebherr, watercooled, output 129 kW (175 h.p.), max. torque 601 lbs-ft. Exhaust emissions acc. to 97/68/EG and EPA/CARB. Fuel reservoir: 66 gallons.

Crane drive	Diesel-hydraulic by 1 axial piston variable displacement twin pump with servo control and power regulation.
Control	Electric "Load Sensing" control, simultaneous operation of 4 working motions, 2 selfcentering hand control levers (joy-stick type), with winch and slewing gear signal devices.
Hoist gear	Axial piston fixed displacement motor, Liebherr hoist drum with integrated planetary gear and spring-loaded static brake.
Luffing gear	1 differential ram with safety check valves.
Slewing gear	Axial piston fixed displacement motor, planetary gear, spring-loaded static brake. Slewing gear invertible from released to locked as standard feature.
Crane cab	Crane cabin fabricated from galvanized steel plates, powder coated, with safety glazing, operation and control elements and comfort features, cab tiltable backwards.
Safety devices	LICCON2 safe load indicator, test system hoist limit switch, safety valves to prevent pipe and hose ruptures.
Telescopic boom	1 base section and 5 telescopic sections. All telescopic sections extendable individually by means of the rapid-cycle telescoping system TELEMATIK. Boom length: 41 ft – 190 ft.
Counterweight	33100 lbs basic counterweight.
Electrical system	Modern data bus technique, 24 Volt DC, 2 batteries of 170 Ah each.

Additional equipment

Swing-away jib	34 ft – 62 ft long, mountable to the telescopic boom at 0°, 20° or 40°. Hydraulic ram for operating the swing-away jib from 0° – 40° (option).
Erection jib	8 ft
Telescopic boom extension	23 ft long lattice section, thus 23 ft higher pinning point for swing-away jib.
2nd hoist gear	For two-hook operation or for operation with swing-away jib if the hoist rope shall remain reeved.
Additional counterweight	17600 lbs for a total counterweight of 50700 lbs.
Tyres	10 tyres, size 525/80 R 25 (20.5 R 25).
Drive 10 x 8	Additionally the first axle can be activated in off road operation.

Other items of equipment available on request.

Equipment Equipment

Châssis porteur

Cadre	Construction en caisse résistante à la torsion et optimisée en poids réalisée par Liebherr en acier de construction à grain fin très rigide.
Stabilisateurs	Dispositif de calage horizontal et vertical en 4 points, entièrement déployable hydrauliquement. Utilisation avec commande à distance, mise à niveau automatique du calage, inclinomètre électronique.
Moteur	Moteur diesel, 6 cylindres, fabriqué par Liebherr, à refroidissement par eau, de 370 kW (503 ch), couple max. 1726 lbs-ft. Emissions des gaz d'échappement conformes aux directives 97/68/EG et EPA/CARB. Capacité du réservoir à carburant: 129 gallons.
Boîte de vitesse	Boîte de vitesses ZF à 12 rapports, mécanisme automatisé à commande AS-TRONIC. Ralentisseur hydrodynamique ZF directement accouplé à la boîte. Boîte de transfert à 2 étages avec blocage de différentiel.
Essieux	Essieux nécessitant peu d'entretien, les 5 essieux sont directeurs. Les essieux 2, 4 et 5 sont des essieux planétaires, tous les essieux moteurs avec différentiel transversal et l'essieu 4 avec différentiel longitudinal.
Suspension	Suspension hydropneumatique sur tous les essieux. Chaque essieu peut être bloqué hydrauliquement.
Pneumatiques	10 pneus de taille: 445/95 R 25 (16.00 R 25).
Direction	2 circuits avec direction assistée hydraulique. Direction active des essieux arrière et dépendante de la vitesse, programmes de direction spéciaux pour les différents modes de déplacement.
Freins	Frein de service: servofrein pneumatique pour toutes les roues, à 2 circuits. Frein à main: accumulateur à ressort agissant sur les roues des essieux 1, 2, 3 et 4. Freins continus: frein moteur par clapet sur échappement avec système de ralentissement Liebherr ZBS. Ralentisseur accouplé à la boîte de vitesses.
Cabine du conducteur	Cabine spacieuse, en tôle d'acier, équipement «grand confort», suspendue sur silent blocs, vitrage de sécurité.
Installation électrique	Composants électriques et électroniques reliés entre eux par bus de données moderne. Courant continu 24 Volts, 2 batteries à 170 Ah chacune.

Partie tournante

Cadre	Fabrication Liebherr, construction soudée indéformable, en acier à grain fin haute résistance. Couronne d'orientation à triple rangée de rouleaux.
Moteur	Moteur diesel Liebherr, 4 cylindres, à refroidissement par eau, de 129 kW (175 ch), couple max. 601 lbs-ft. Emissions des gaz d'échappement conformes aux directives 97/68/EG et EPA/CARB. Capacité du réservoir à carburant: 66 gallons.

Entraînement de la grue	Diesel-hydraulique avec 1 double pompe à débit variable à pistons axiaux avec servo-commande et régulation de puissance.
Direction	Commande électrique «Load Sensing», 4 mouvements de travail dirigeables simultanément, deux leviers de commande à 4 positions et à autocentrage, avec capteur de rotation des treuils et du mécanisme d'orientation.
Mécanisme de levage	Moteur à cylindrée constante et à pistons axiaux. Treuil de marque Liebherr équipé d'un engrenage planétaire et d'un frein d'arrêt commandé par ressort.
Mécanisme de relevage	1 vérin différentiel avec soupapes de retenu.
Dispositif de rotation	Moteur à cylindrée constante à pistons axiaux, réducteur planétaire, frein d'arrêt commandé par ressort. Commutation en série du mécanisme d'orientation: ouvert et en orientation freinée automatiquement.
Cabine du grutier	Cabine en tôle électrozinguée, peinture par poudrage et cuisson au four, avec vitres de sécurité, éléments de commande et de contrôle et équipement confortable, cabine inclinable vers l'arrière.
Dispositif de sécurité	Contrôleur de charge «LICCON2», système test limitation de la course pour le levage, soupape de sûreté contre la rupture de tubes et de tuyaux.
Flèche télescopique	Un élément de base et de 5 télescopes. Chaque partie peut être télescopée individuellement à l'aide du système de télescopage séquentiel rapide TELEMATIK. Longueur de flèche: 41 ft – 190 ft.
Contrepoids	Contrepoids principal de 33100 lbs.
Installation électrique	Technique moderne de transmission de données par BUS de données. Courant continu 24 Volts, 2 batteries de 170 Ah chacune.

Équipement supplémentaire

Fléchette pliante	Longueur: 34 ft – 62 ft, montable sous un angle de 0°, 20° ou 40°. Vérin hydraulique pour le relevage de la fléchette pliante de 0° à 40° (en option).
Fléchette de montage	8 ft
Rallonge flèche télescopique	Élément en treillis de 23 ft, élevant le point d'articulation pour la fléchette pliante de 23 ft.
2ème mécanisme de levage	Pour l'utilisation du deuxième crochet, ou bien pour une utilisation avec fléchette pliante lorsque le câble de levage principal rest moufflé.
Contrepoids supplémentaire	17600 lbs pour un contrepoids total de 50700 lbs.
Pneumatiques	10 pneus. Taille: 525/80 R 25 (20.5 R 25).
Entraînement 10 x 8	L'essieu 1 peut également être activé sur le terrain.

Autres équipements supplémentaires sur demande.

Remarks referring to load charts

1. The lifting capacities do not exceed 85 % of the tipping load according to ASME B 30.5.
The crane's structural steelwork is in accordance with EN 13000 and ASME B 30.5.
2. For the calculation of the load charts at least a wind speed of 23 ft/s (7 m/s, 15.7 mph) and regarding the load a sail area of 1 m² per ton load and a wind resistance coefficient of 1.2 on the load have been taken into account. For lifting of loads with large sail areas and/or high wind resistance coefficients the maximum wind speed as stated in the load charts has to be reduced.
3. Lifting capacities are given in kips.
4. The weight of the hook blocks and hooks must be deducted from the lifting capacities.
5. Working radii are measured from the slewing centreline.
6. The lifting capacities given for the telescopic boom only apply if the folding jib is taken off.
7. Lifting capacities above 138.9 kips / 187.4 kips only with additional pulley block/special equipment.
8. The data of this brochure serves only for general information. All information is provided without warranty. Instructions for the correct commissioning of the crane please take from the operation manual and the load chart book.

Remarques relatives aux tableaux des charges

1. La capacité de charge ne doit pas dépasser 85 % de la charge de basculement conformément à ASME B 30.5.
La structure métallique de la grue est conforme à EN 13000 et ASME B 30.5.
2. Une vitesse de vent de 23 ft/s (7 m/s, 15.7 mph) minimum, une surface de prise au vent de 1 m² par tonne ainsi qu'un coefficient de résistance au vent de la charge 1,2 sont pris en compte pour le calcul des tableaux de charge. Lorsque des charges ayant une surface de prise au vent et/ou un coefficient de résistance au vent plus élevé(e)s sont levées, la vitesse de vent maximale indiquée dans les tableaux de charge doit être réduite.
3. Les forces de levage sont données en kips.
4. Les poids des mouffes et crochets doit être soustrait des charges indiquées.
5. Les portées sont calculées à partir de l'axe de rotation.
6. Les forces indiquées pour la flèche télescopique s'entendent fléchette dépliée.
7. Forces de levage plus de 138.9 kips / 187.4 kips seulement avec moufle additionnel/équipement supplémentaire.
8. Les données de cette brochure sont données à titre informatif. Ces renseignements sont sans garantie. Les consignes relatives à la bonne mise en service de la grue sont disponibles dans le manuel d'utilisation et le manuel de tableaux de charge.

Subject to modification / Sous réserve de modifications

Printed in Germany (1)

TD 208.01.US10.2012

Liebherr-Werk Ehingen GmbH

Postfach 1361, 89582 Ehingen, Germany

☎ +49 73 91 5 02-0, Fax +49 73 91 5 02-33 99

www.liebherr.com, E-mail: info.lwe@liebherr.com

www.facebook.com/LiebherrConstruction